

# Machine Controller MP900/MP2000 Series New Ladder Editor USER'S MANUAL

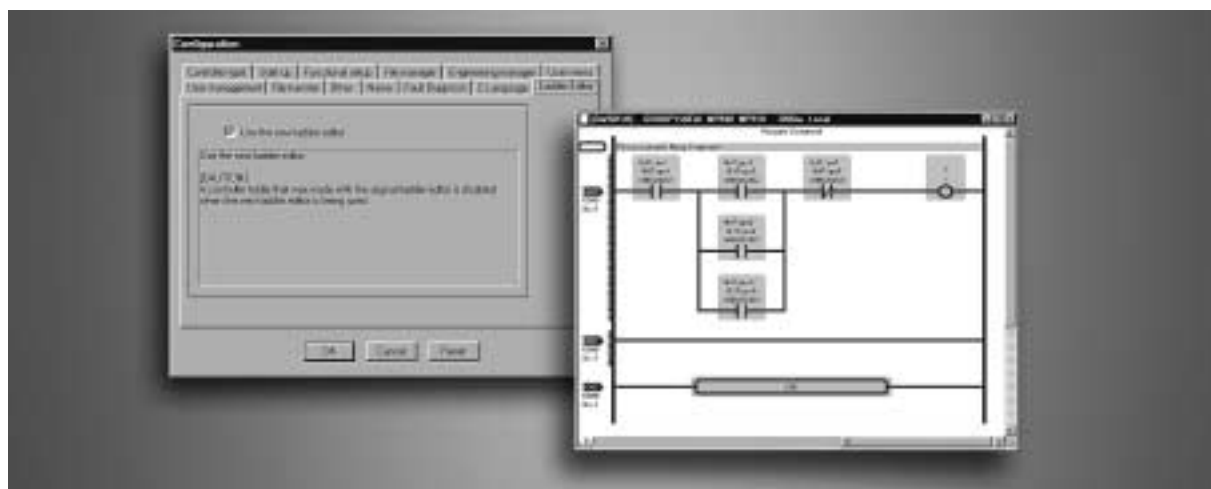

Copyright © 2001 YASKAWA ELECTRIC CORPORATION

---

All rights reserved. No part of this publication may be reproduced, stored in a retrieval system, or transmitted, in any form, or by any means, mechanical, electronic, photocopying, recording, or otherwise, without the prior written permission of Yaskawa. No patent liability is assumed with respect to the use of the information contained herein. Moreover, because Yaskawa is constantly striving to improve its high-quality products, the information contained in this manual is subject to change without notice. Every precaution has been taken in the preparation of this manual. Nevertheless, Yaskawa assumes no responsibility for errors or omissions. Neither is any liability assumed for damages resulting from the use of the information contained in this publication.

---

## About This Manual

- This manual describes the operation of the New Ladder Editor, a programming software application that aids in the design and maintenance of MP900-series and MP2000 series Machine Controllers.
- This manual is written for readers with a working knowledge of Microsoft Windows 95/98/2000/NT. Refer to Windows documentation provided with your computer for information on basic operations, such as opening and closing windows and mouse operations.
- **Intended Audience**

This manual is intended for the following users.

- Those responsible for designing the MP900 and MP2000 System
- Those responsible for writing MP900 and MP2000 motion programs
- Those responsible for writing MP900 and MP2000 ladder logic programs

- **Description of Technical Terms**

In this manual, the terms are defined as follows:

- MPE720 = The Programming Device Software or a Programming Device (i.e., a personal computer) running the Programming Device Software and MP2000
- PLC = Machine Controller

- Read this manual carefully to ensure the proper use of the New Ladder Editor. Also, keep this manual in a safe place so that it can be referred to whenever necessary.

## About The Software

- **Precautions**

- This software is to be installed on one and only one computer. You must purchase another copy of the software to install it on another computer.
- This software is not to be copied for any reason other than when installing it on the computer.
- Store the floppy disks containing the software in a safe place.
- This software is not to be decompiled, disassembled, or reverse engineered.
- This software is not to be given to, rent to, exchanged with, or otherwise released to a third party without the prior permission of Yaskawa Corporation.

- **Trademarks**

- Windows and Windows 95/98/2000/NT are registered trademarks of Microsoft Corporation.
- Pentium is a registered trademark of Intel Corporation.
- Ethernet is a registered trademark of Xerox Corporation.

---

## Visual Aids

The following aids are used to indicate certain types of information for easier reference.

**IMPORTANT**

Indicates important information that should be memorized. Also indicates low-level precautions that, if not heeded, may cause an alarm to sound but will not result in the device being damaged.

**◀ EXAMPLE ▶**

Indicates application examples.



Indicates supplemental information.

## Related Manuals

The MP900 series Machine Controllers consists of four models, the MP910, MP920, MP930, and MP940.

The MP2000 series Machine Controllers consists of two models, the MP2100 and MP2300. Manuals have been produced on these products line.

The following table shows related manuals for the MP900 and MP2000 series.

Refer to the following related manuals as required.

Manual Name	Manual Number	Applicable Model					
		MP910	MP920	MP930	MP940	MP2100	MP2300
Machine Controller MP930 User's Manual: Design and Maintenance	SIEZ-C887-1.1			√			
Machine Controller MP900/MP2000 Series User's Manual: Ladder Programming	SIEZ-C887-1.2	√	√	√	√	√	√
Machine Controller MP900/MP2000 Series User's Manual: Motion Programming	SIEZ-C887-1.3	√	√	√	√	√	√
Machine Controller MP900 Series Teach Pendant User's Manual	SIEZ-C887-1.6		√	√			
Machine Controller MP920 User's Manual: Design and Maintenance	SIEZ-C887-2.1		√				
Machine Controller MP900 Series Programming Panel Software User's Manual for Simple Operation	SIEZ-C887-2.3	√	√	√	√		
Machine Controller MP920 User's Manual: Motion Module	SIEZ-C887-2.5		√				
Machine Controller MP920 User's Manual: Communications Module	SIEZ-C887-2.6		√				
Machine Controller MP920 Installation Manual	SIEZ-C887-2.50		√				
Machine Controller MP910 User's Manual: Design and Maintenance	SIEZ-C887-3.1	√					
Machine Controller MP940 User's Manual: Design and Maintenance	SIEZ-C887-4.1				√		
Machine Controller MP940 Installation Manual	SIEZ-C887-4.50				√		
Machine Controller MP900/MP2000 Series MECHATROLINK System User's Manual	SIEZ-C887-5.1	√	√	√	√		
Machine Controller MP900 Series 260IF DeviceNet System User's Manual	SIEZ-C887-5.2		√		√		
Machine Controller MP900 Series MPLoader (Server) User's Manual for Server	SIEZ-C887-12.1		√	√	√		
Machine Controller MP900 Series MPLoader (Client) User's Manual for Client	SIEZ-C887-12.2		√	√	√		

(cont'd)

Manual Name	Manual Number	Applicable Model					
		MP910	MP920	MP930	MP940	MP2100	MP2300
Machine Controller MP900/MP2000 Series New Ladder Editor Programming Manual	SIEZ-C887-13.1	√	√	√	√	√	√
Machine Controller MP900/MP2000 Series New Ladder Editor User's Manual	SIEZ-C887-13.2	√	√	√	√	√	√
Machine Controller MP2100/MP2100M User's Manual: Design and Maintenance	SIEPC88070001					√	
Machine Controller MP2300 Basic Module User's Manual	SIEPC88070003						√
Machine Controller MP2300 User's Manual: Communications Module	SIEPC88070004						√
Machine Controller MP900/2000 Series MPE720 Software for Programming Device User's Manual	SIEPC88070005	√	√	√	√	√	√

---

# CONTENTS

About This Manual	iii
About The Software	iii
Visual Aids	iv
Related Manuals	v

## 1 BASIC OPERATION

1.1 CONFIGURATION	1-2
1.2 FILE MANAGER	1-3
1.2.1 Folder Display	1-3
1.2.2 Program File Display	1-3
1.3 CREATING NEW PROGRAM	1-5
1.3.1 Off-line Mode	1-5
1.3.2 On-line Mode	1-6
1.3.3 Create New Function	1-8
1.4 OPEN A PROGRAM	1-12
1.4.1 Open as New Window	1-12
1.4.2 Open as New Sheet	1-13
1.5 LADDER EDITOR VIEW	1-16
1.5.1 Components of Ladder Editor	1-16
1.5.2 Select View	1-17
1.6 TOOL BAR	1-22
1.6.1 Display Mode	1-22
1.6.2 Tool Bar Function	1-23
1.7 KEYBOARD OPERATION	1-24
1.7.1 Keyboard Operations on a Rung	1-24
1.7.2 Shortcut Keys	1-24

## 2 PROGRAMMING

2.1 PROGRAMMING	2-3
2.1.1 Object	2-3
2.2 SELECT	2-7
2.2.1 Select Object and Display	2-7
2.2.2 Cursor Operation	2-11
2.2.3 Select Multiple Objects	2-13
2.2.4 Range Selection with Mouse	2-14
2.3 INSERT	2-17
2.3.1 Insert Rung Comment	2-17
2.3.2 Insert Rung	2-18
2.3.3 Insert Instruction	2-20
2.3.4 Insert Branch	2-24

2.4	DELETE	2-26
2.4.1	Delete Rung Comment	2-26
2.4.2	Delete Rung	2-27
2.4.3	Delete Instruction	2-28
2.4.4	Delete Branch	2-29
2.5	BRANCH OPERATION	2-30
2.5.1	Branch Operation Mode	2-30
2.5.2	Create Branch	2-30
2.5.3	Edit Branch	2-32
2.5.4	Delete Branch	2-33
2.6	EDIT CHARACTER STRING	2-34
2.6.1	Edit Character String in the Program Comment	2-34
2.6.2	Edit Character String in the Rung Comment	2-35
2.6.3	Edit Character String in the Instruction	2-36
2.7	EDIT OBJECT	2-44
2.7.1	Edit Single Instruction	2-44
2.7.2	Edit Operand of Instruction	2-49
2.7.3	Edit Multiple Objects	2-52
2.7.4	Undo	2-57
2.7.5	Redo	2-57
2.8	SAVE PROGRAM	2-58
2.8.1	Save	2-58
2.8.2	Save All	2-59
2.9	VERIFY PROGRAM	2-60
2.9.1	Verify	2-60
2.9.2	Verify All Program	2-62
3	DISPLAY	
3.1	EDITOR OPTION DIALOG	3-2
3.1.1	Editor Option Dialog Configuration	3-2
3.1.2	Color	3-2
3.1.3	Font	3-5
3.1.4	Ladder Display	3-6
3.1.5	Control	3-9
3.1.6	Key	3-10
3.2	ZOOM	3-11
3.3	INSTRUCTION PALETTE	3-12
3.3.1	Instruction Palette	3-12
3.3.2	User Customized Tab	3-13
3.3.3	Quick View Property	3-16
3.4	OUTPUT WINDOW	3-18
3.4.1	Output Window Display	3-18
3.4.2	Detail of the Output Window	3-19



3.5	TOOLBAR CUSTOMIZE DIALOG	3-20
3.5.1	Display and Configuration of Toolbar Customize Dialog	3-20
3.5.2	Commands	3-20
3.5.3	Toolbars	3-21
3.5.4	Keyboard	3-22
3.5.5	Other	3-23
3.5.6	Edit Icon Image	3-24
3.5.7	Customizing Operation	3-28
3.6	FUNCTION KEYS	3-29
3.6.1	Function Bar	3-29
3.6.2	Function Key Assignment	3-30
4	FIND/REPLACE	
4.1	FIND	4-2
4.1.1	Find	4-2
4.1.2	Find from Files	4-6
4.2	REPLACE	4-10
4.3	CROSS REFERENCE	4-14
4.3.1	Display Cross Reference Window	4-14
4.3.2	Cross Reference Condition	4-16
4.3.3	Output to File	4-18
5	SYMBOL DATABASE	
5.1	SYMBOL MANAGER	5-2
5.1.1	Symbol Manager Menu	5-2
5.1.2	Data Tree	5-3
5.2	SYMBOL LIST	5-4
5.2.1	Symbol List	5-4
5.2.2	Add Symbol	5-6
5.2.3	Insert Symbol	5-7
5.2.4	Delete Symbol	5-8
5.2.5	Import Symbol Data	5-9
5.2.6	Export Symbol Data	5-10
5.2.7	Find/Replace	5-11
5.3	REGISTER MAP	5-16
5.3.1	Register Map	5-16
5.4	AUTOMATIC ADDRESS ALLOCATION	5-18
5.4.1	Automatic Address Allocation	5-18
5.4.2	Setting of Register Area	5-19
5.4.3	Execution of Automatic Address Allocation	5-20
5.5	OPERATION IN LADDER EDITOR	5-21
5.5.1	Display Symbol List	5-21
5.5.2	Display Register Map	5-23
5.5.3	Unregistered Symbol List	5-26

---

## 6 DEBUGGING

6.1 BASIC FUNCTION	6-2
6.1.1 Display Current Values	6-2
6.1.2 SYNC	6-3
6.1.3 HOLD (supported in the future)	6-4
6.2 DISABLE COILS	6-5
6.2.1 Display	6-5
6.2.2 Set Disable ON	6-6
6.2.3 Set Disable OFF	6-6
6.2.4 Cancel Disable	6-7
6.3 REFER	6-8
6.3.1 Refer on the SEE Instruction	6-8
6.3.2 Refer on the FUNC Instruction	6-9
6.4 QUICK REFERENCE	6-10
6.4.1 Display	6-10
6.4.2 Register List Page	6-11
6.4.3 Watch Page	6-14
6.4.4 The definition data is added from the ladder editor.	6-17
6.5 CURRENT VALUE MONITOR	6-18
6.5.1 Display of Current Value Monitor Window	6-18
6.5.2 Start and Stop Current Value Monitor	6-21
6.5.3 Pop-up Menu	6-22

## 7 PRINTING

7.1 PRINT PREVIEW	7-2
7.2 PRINTING	7-5
7.3 PAGE SETUP	7-7

## 8 LADDER CONVERSION TOOL

8.1 START LADDER CONVERSION TOOL	8-2
8.2 LADDER CONVERSION TOOL	8-3
8.3 MENU	8-7

## Appendix A

A.1 MENU	A-2
----------	-----

## Appendix B

B.1 MENU in SYMBOL MANAGER	B-2
----------------------------	-----

## Revision History

# BASIC OPERATION

This section describes the basic operation of the ladder editor.

1.1 CONFIGURATION	1-2
1.2 FILE MANAGER	1-3
1.2.1 Folder Display	1-3
1.2.2 Program File Display	1-3
1.3 CREATING NEW PROGRAM	1-5
1.3.1 Off-line Mode	1-5
1.3.2 On-line Mode	1-6
1.3.3 Create New Function	1-8
1.4 OPEN A PROGRAM	1-12
1.4.1 Open as New Window	1-12
1.4.2 Open as New Sheet	1-13
1.5 LADDER EDITOR VIEW	1-16
1.5.1 Components of Ladder Editor	1-16
1.5.2 Select View	1-17
1.6 TOOL BAR	1-22
1.6.1 Display Mode	1-22
1.6.2 Tool Bar Function	1-23
1.7 KEYBOARD OPERATION	1-24
1.7.1 Keyboard Operations on a Rung	1-24
1.7.2 Shortcut Keys	1-24

## 1.1 CONFIGURATION

When the new ladder editor method is used, the configuration needs to be set.

1. Select **View (V) - Configuration (C)** of the File Manager menu.

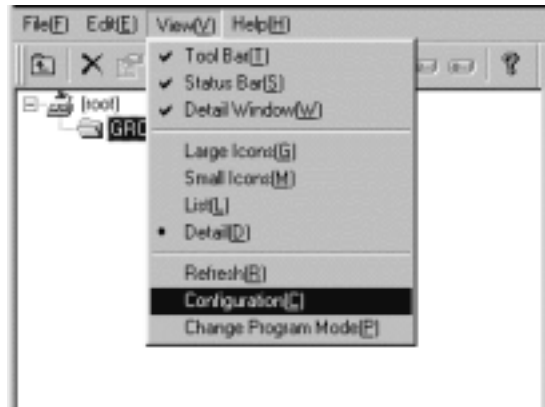

2. "Configuration" dialog box is displayed. Select the Ladder Program tab, and place a check mark in "Use the new ladder program description".

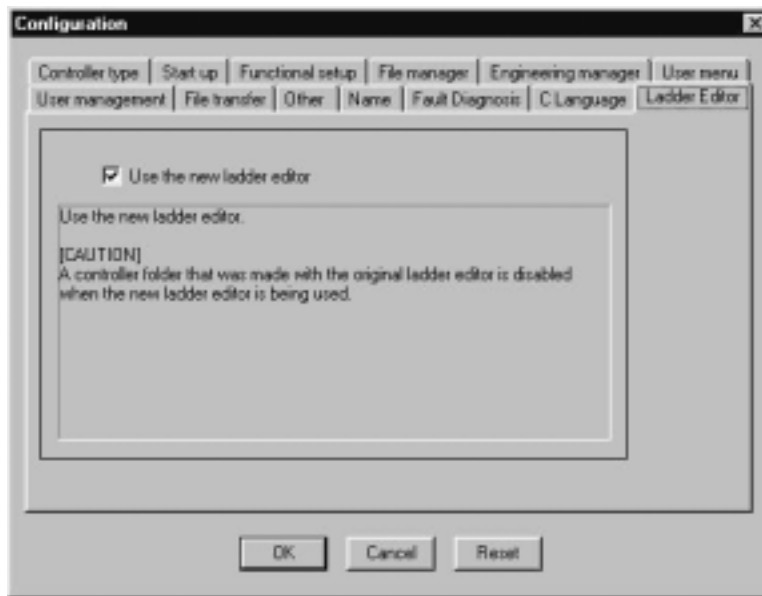

3. Click [OK] button. This setting is available after restarting the File Manager.



If the new ladder program description is selected, all folders created in the original Ladder editor are not available.

## 1.2 FILE MANAGER

The display of the file manager is different in the following respects from the original ladder program editor to the new ladder editor.

### 1.2.1 Folder Display

The PLC folder and CPU folder that were made using the original ladder editor are shown in the figure below and cannot be used.

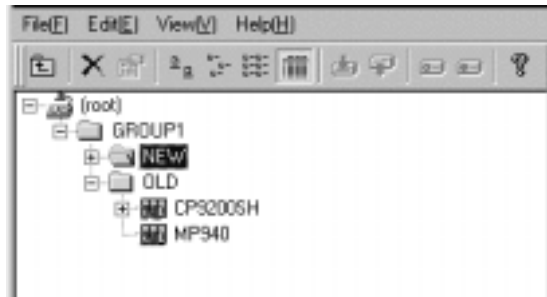

### 1.2.2 Program File Display

There are the following six kinds of program files displayed in the File Manager.

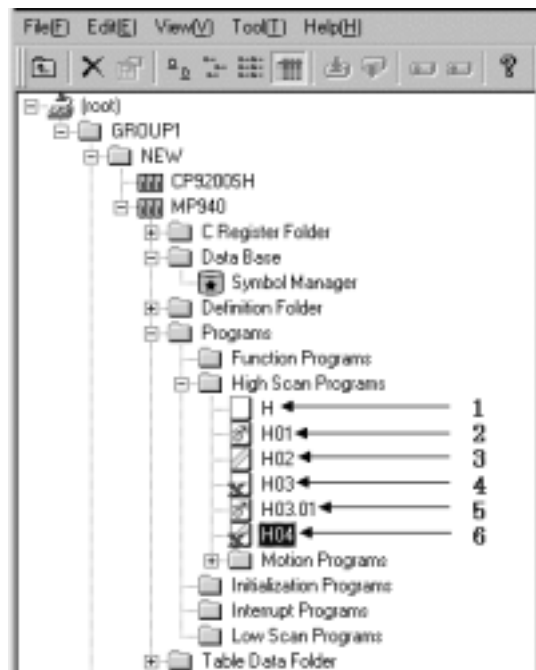

1. Not Compiled file that is available in off-line mode.

The program file displays the program without executing the compilation (or verifying). In the new ladder editor, the program can be saved as a file even if compiled.

Refer to 2.9 Verifying Program.

2. Compiled File.

The program file displays the program already compiled.

3. Unmatched File

The program file displays the program that has be unmatched in some cases.

There are three cases that cause unmatched.

- Unmatched version number of data in the controller
- Unmatched version number of data between the controller and the hard disk on PC
- Unmatched CPU environment

When unmatched file is edited, possibility of the restoration of data and how to restore data are displayed as a message.

4. Not Compiled and Disabled file that is available at off-line mode.

The program file displays the disabled program without executing the compilation (or verifying). In a new ladder editor, the program can be saved as a file even if compiled.

5. Compiled and Disabled File.

The program file displays the disabled program already compiled.

6. Unmatched and Disabled File

The program file displays the disabled program that is unmatched in some cases.

**IMPORTANT**

It is necessary to adjust all files by loading or dumping CPU environment when programs are edited connected with the controller at on-line mode.



Compile (verification) of the program file created by the Ladder editor of a new version (Ver.4.xx) generates automatically the program file of the same from as the conventional version (Ver.3.xx).

This file should not edit by the conventional version. It becomes impossible to edit the file by the Ladder editor of a new Version, when this work is performed.

The following comment is inserted automatically in the program file of conventional form.

```
0000 "Ladder Compiler Version: 1.00"
0001 "[CAUTION]: Don't edit this file."
0002 "This program code is generated automatically."
0003 "If you edit this program, you can't it edit it on"
0004 "the any other editor."
```

## 1.3 CREATING NEW PROGRAM

The programs can be created from every folder such as High Scan Programs at Program folder.

### 1.3.1 Off-line Mode

1. Select the folder suitable to the type of program.
2. Select **File (F) - Create New DWG (N)** from the File Manager menu or from the popup menu.

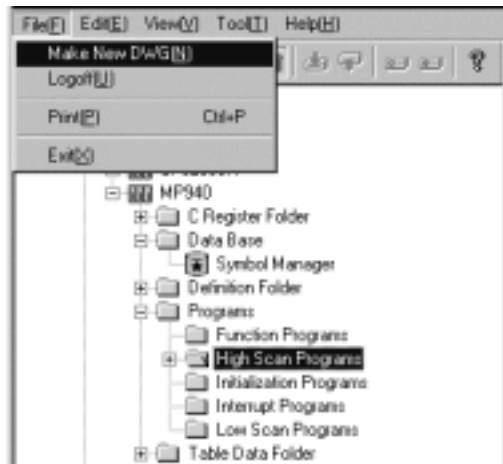

3. "Input DWG Name" dialog box is displayed.

Input the program name and select the type of program. Click [OK] button.



4. New program is created. New program is displayed in the File Manager window.

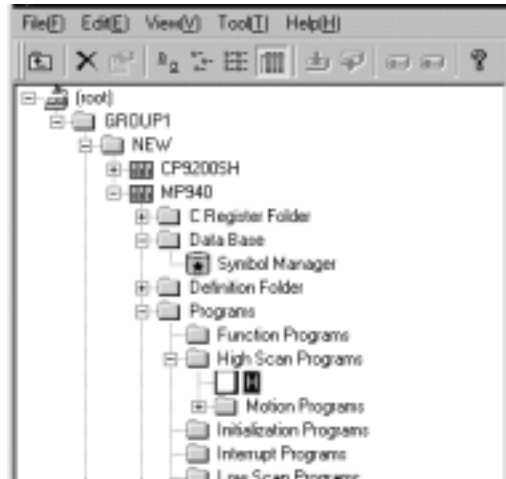

END instruction is prepared in a new program automatically.

### 1.3.2 On-line Mode

Make sure to log on the Controller to create programs or definition data for the controller.

1. Select the CPU folder or controller folder to be logged on. Select **Log On (G)** from **File (F)** of the File Manager menu or from the popup menu.

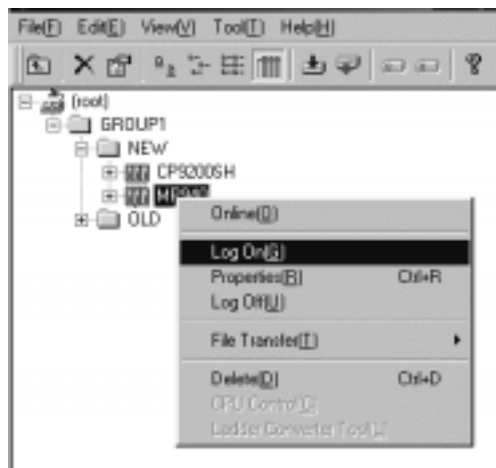

2. Select the folder suitable to the kind of program.
3. Select **File (F) - Create New DWG (N)** of the File Manager menu or from the popup menu.



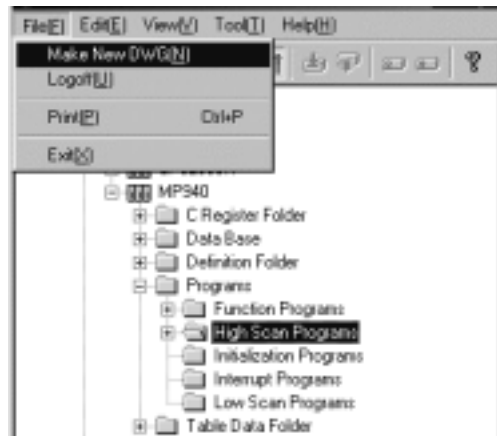

4. "Input DWG Name" dialog box is displayed.

Input the program name and select the type of program. Click [OK] button.



5. The new program is compiled and downloaded to the controller at the same time as it is created. New program is displayed as a Compiled file in the File Manager window.

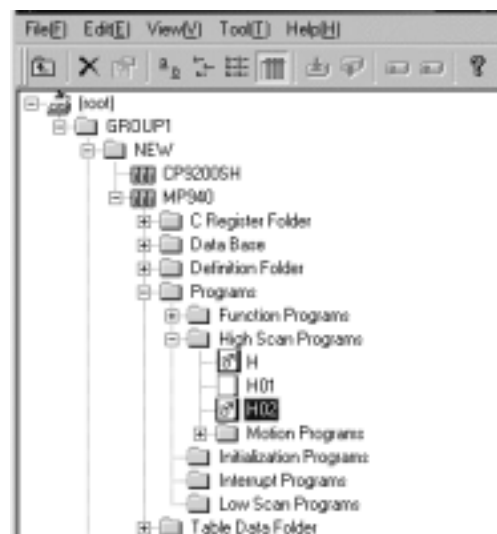

6. Then the ladder editor is opened.

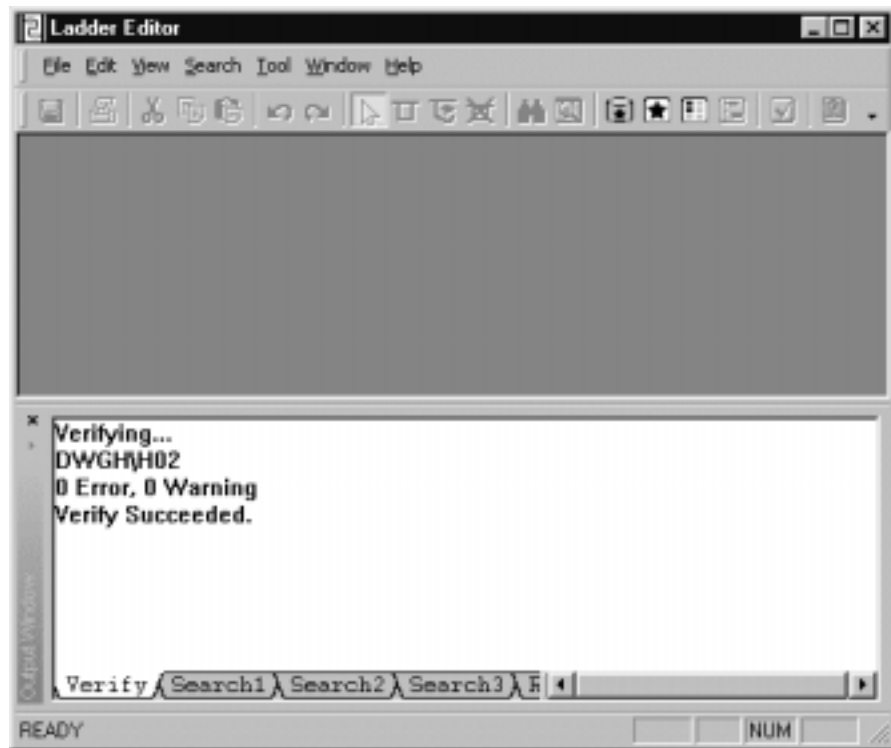

### 1.3.3 Create New Function

1. Select a function folder.
2. Select **File (F) - Create New DWG (N)** from File Manager menu or the popup menu.

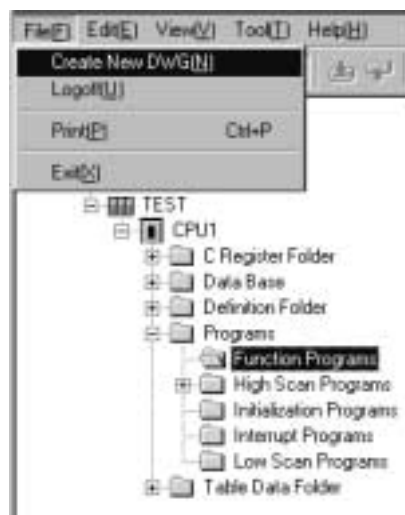

3. "Input DWG Name" dialog box is displayed.

Input the function name and select the "FUNC" in DWG Type, Click [OK] button.



4. New function is created.

New function is displayed in the File Manager window.

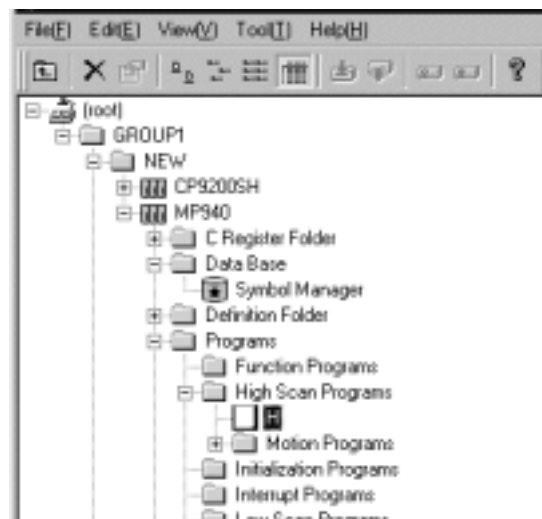

## 5. Define the I/O of New function.

Select a function file.

Select **File (F) - Property (R)** from File Manager menu or the popup menu.

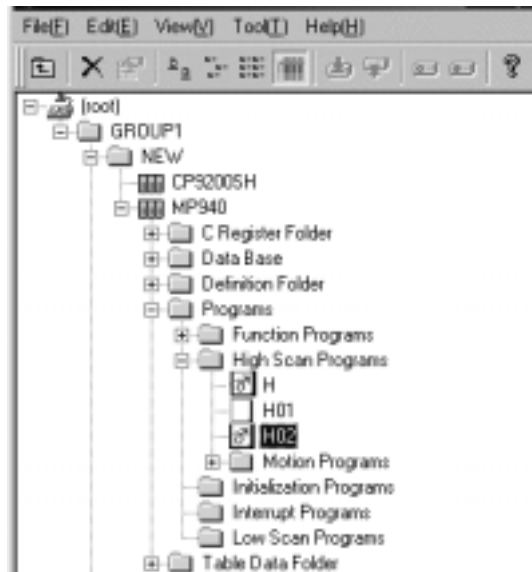

### ■ I/O Definition of Function

Define the I/O of function.

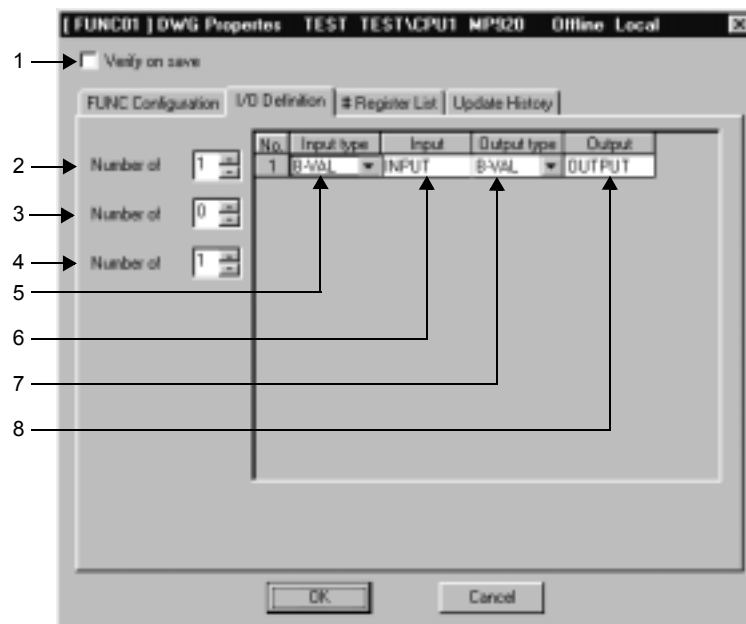

## 1. Verify on save

Function is verified on saving the property.

## 2. Number of Input

Input the number of inputs to the function, in the range from 1 to 16.

3. Number of address Input

Input 1 to input, and 0 not to input the address.

4. Number of output

Input the number of outputs to the function, in the range from 1 to 16.

5. Input type

Select the input data type for the function.

6. Input

Input the comment on the input data of the function with 8 or less characters.

7. Output type

Select the output data type for the function.

8. Output

Input the comment on the output data of the function with 8 or less characters.

## Data types

The data types to selected at step 5 and 7 are shown in the table below.

Item	Data type
B-VAL	Bit type
I-REG	Integer type
L-LEG	Double-length integer type
F-REG	Real-number type

## 1.4 OPEN A PROGRAM

Open the program file in below a program folder.

### 1.4.1 Open as New Window

The additional display of another program is carried out in a new window.

1. Select a program file.
2. Select **File (F) - Open as new window (W)** from the File Manager or from the popup menu.

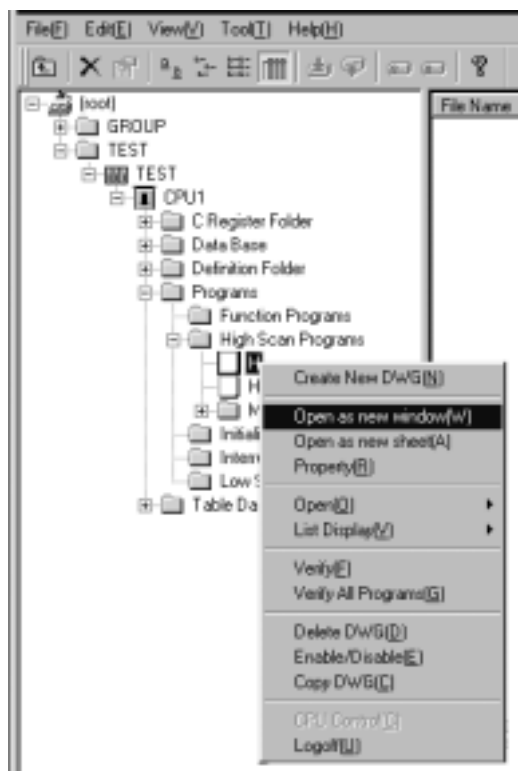

3. A program is displayed in a new window.

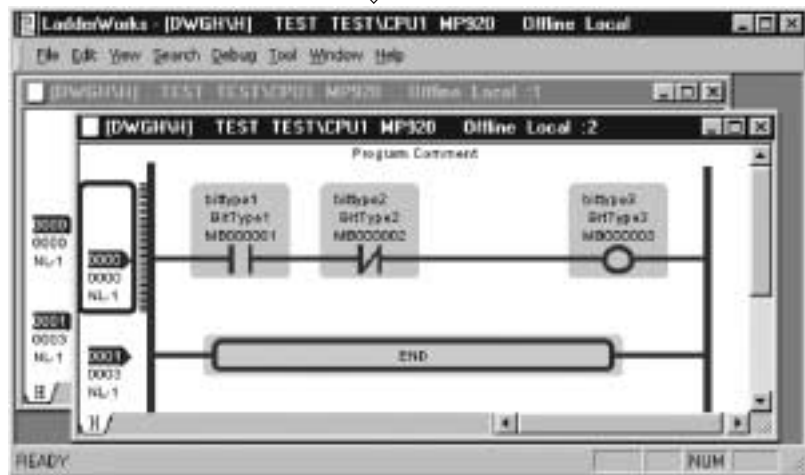
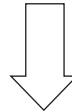
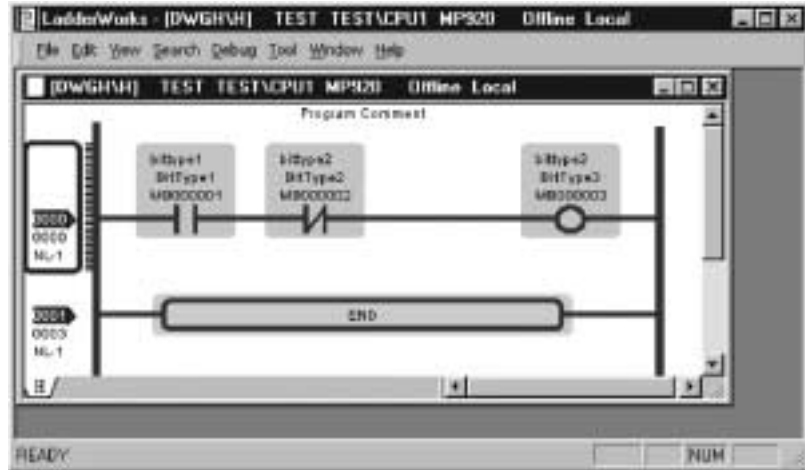

## 1.4.2 Open as New Sheet

The additional display of another program is carried out in a new Sheet.

1. Select a program file.

2. Select **File (F) - Open as new Sheet (A)** from the File Manager or from the popup menu.

<Mouse operation: > Double click a program file

<Key operation: > Push Enter key on a program file

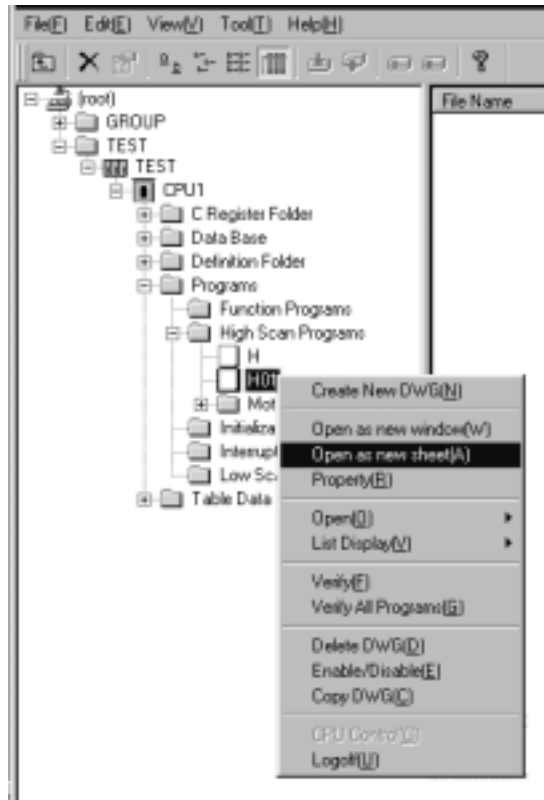

3. A program is displayed in a new sheet.

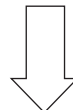
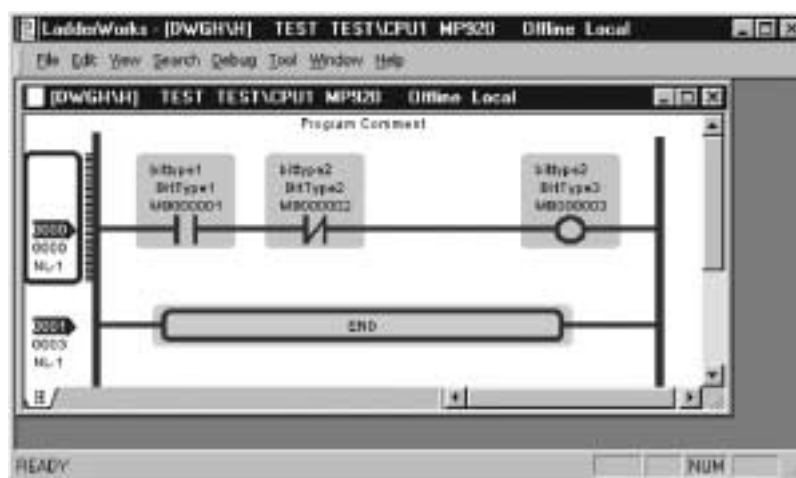



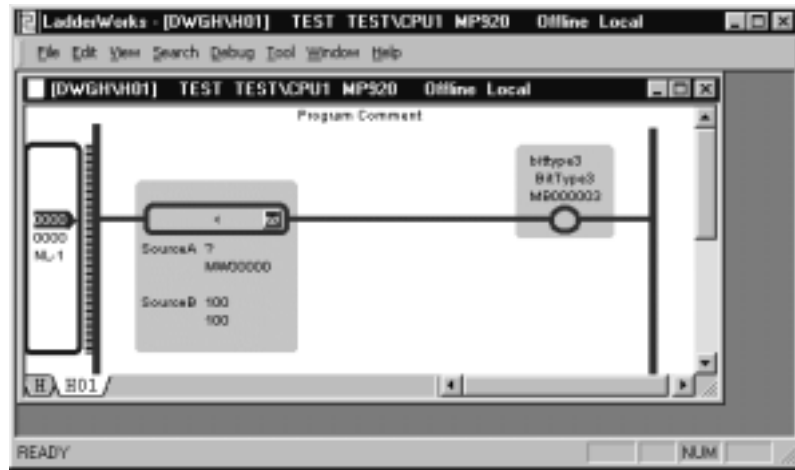

1

## 1.5 LADDER EDITOR VIEW

### 1.5.1 Components of Ladder Editor

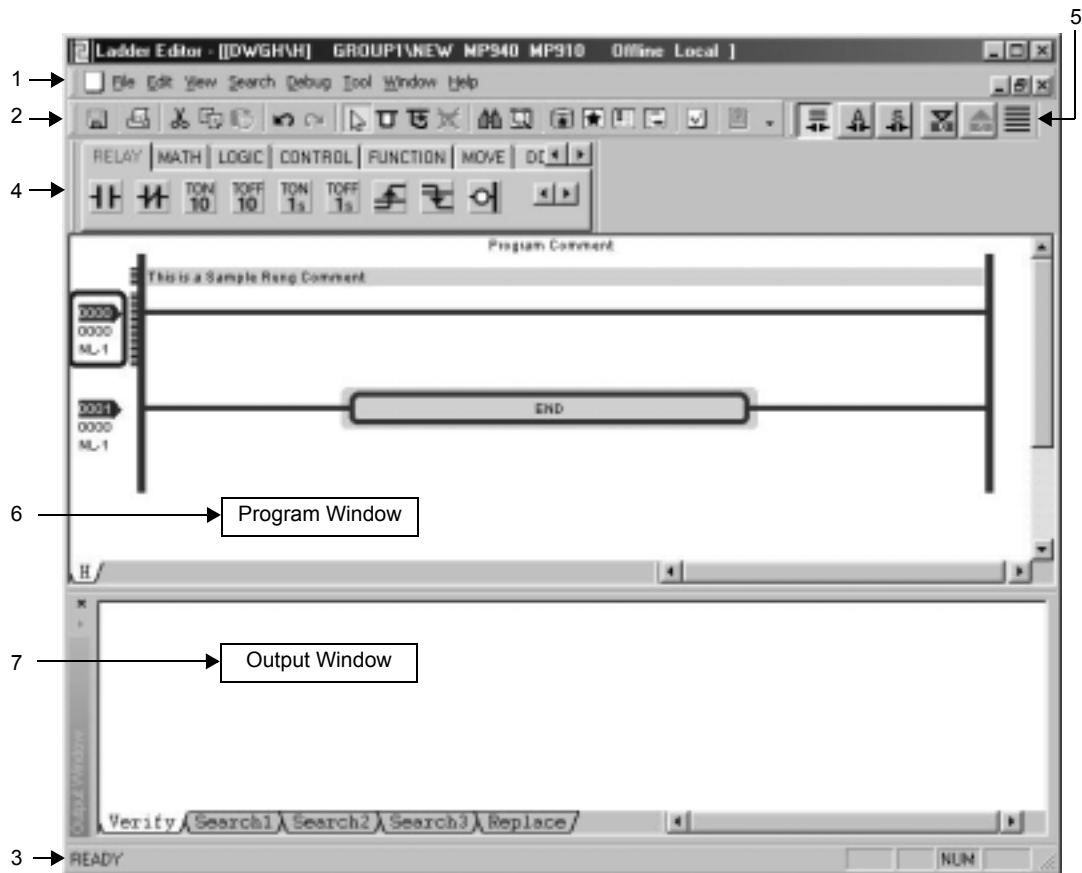

1. Menu bar

The menu is displayed at the top part of a window.

2. Tool bar

Each operation of function such as editing function of the menu is displayed with an icon.

3. Status bar

A message of the system is displayed.

4. Instruction palette

Each instruction used to create a program is displayed on the palette as an icon.

5. Quick view property

Display format is set.

6. Program window

The program is created on this window. Each program is displayed by the bottom tab.

7. Output Window

The result of them are displayed when the Verify, Find, and Replace operation is executed.

## 1.5.2 Select View

### ■ Bottom Tab

Select the tab in the program window, and selected program is displayed.

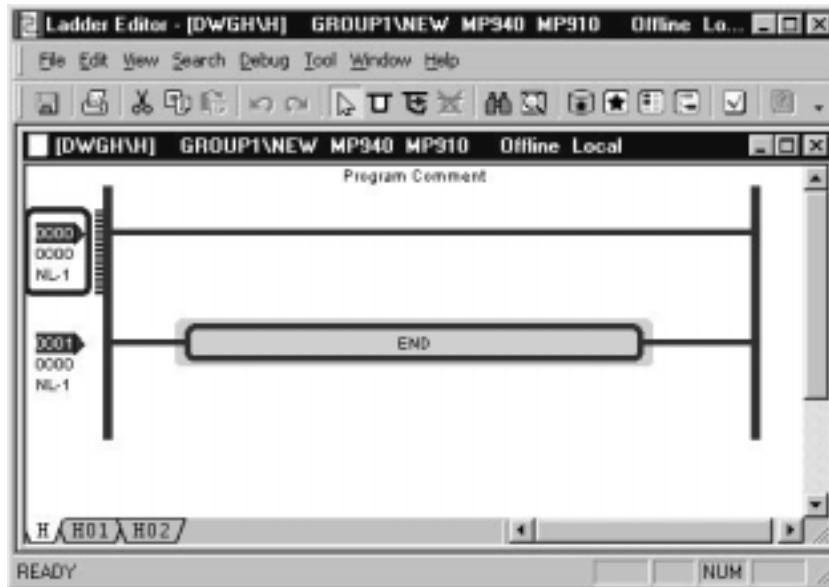

### ■ Multi-Window

#### Cascade

Select **Window (W) - Cascade (D)** to display the currently opened windows of one over the other.

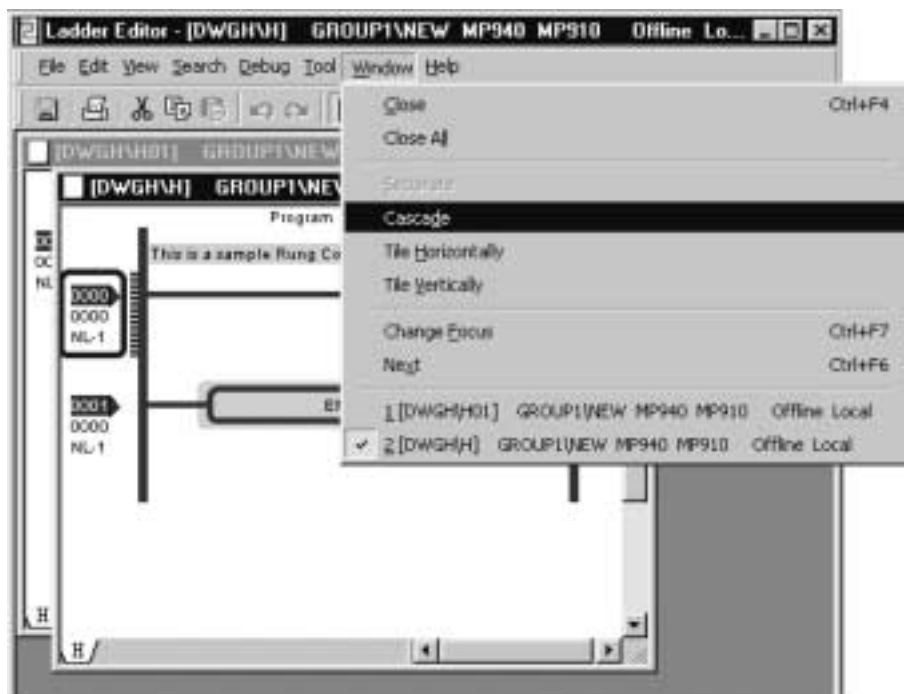

Next

Select **Window (W) - Next (X)** to change the active program window.

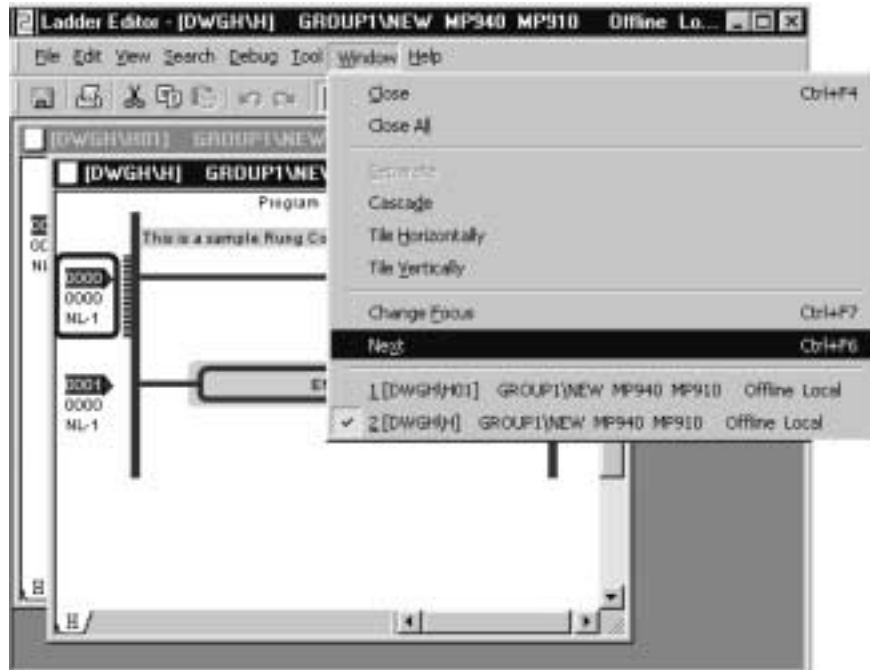

## ■ Tile

Tile Horizontally

Select **Window (W) - Tile Horizontally (H)** to display the currently opened windows of one by one horizontally.

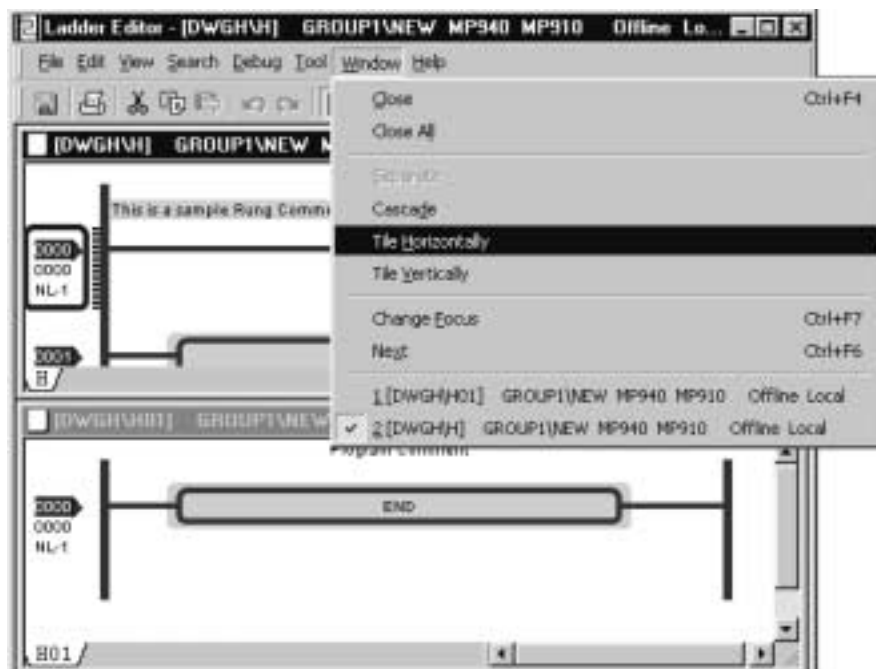

## Tile Vertically

Select **Window (W) - Tile Vertically (H)** to display the currently opened windows of one by one vertically.

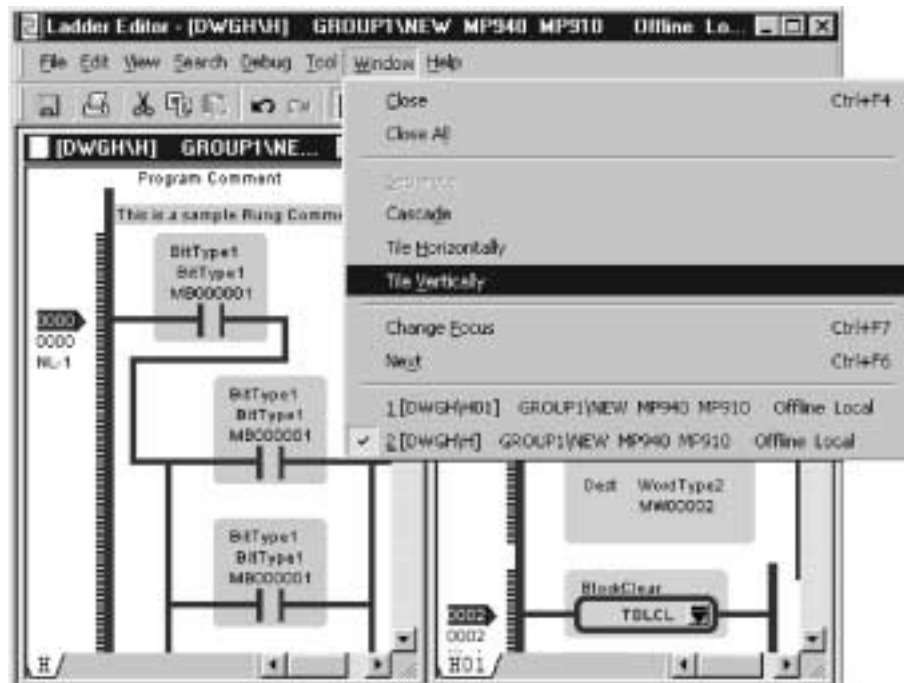

### ■ Change Focus

Select **Window (W) - Change Focus (F)** to change the active window such as program window, output window in the ladder editor.



This is different from Next function that changes the active program in the program window.

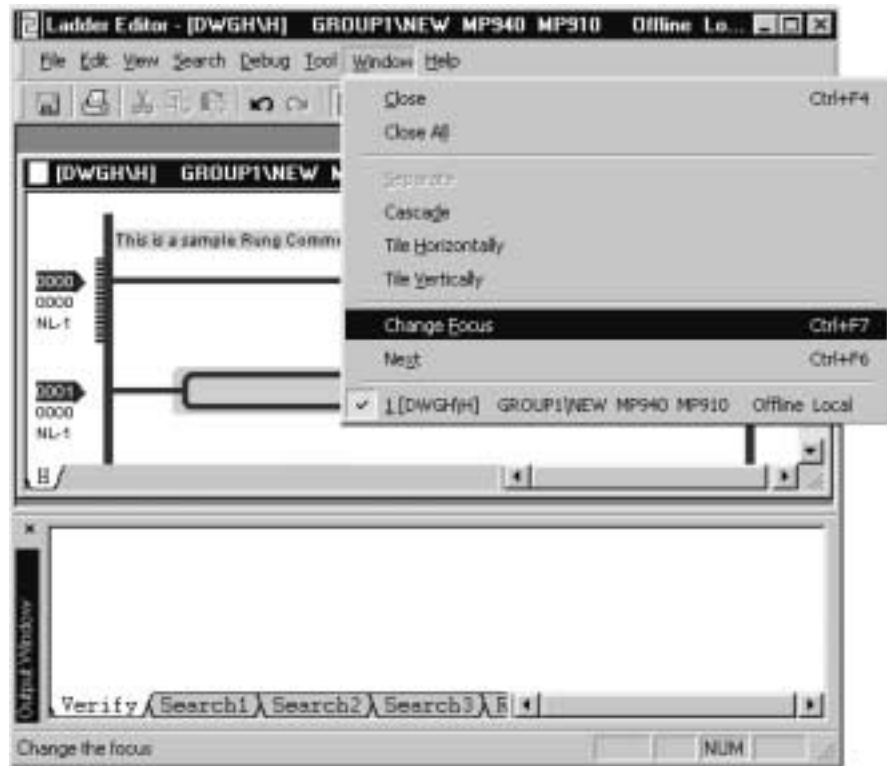

■ Change the Maximum Size of Program Window

Click the button on the title bar to display the maximum size of the program window.

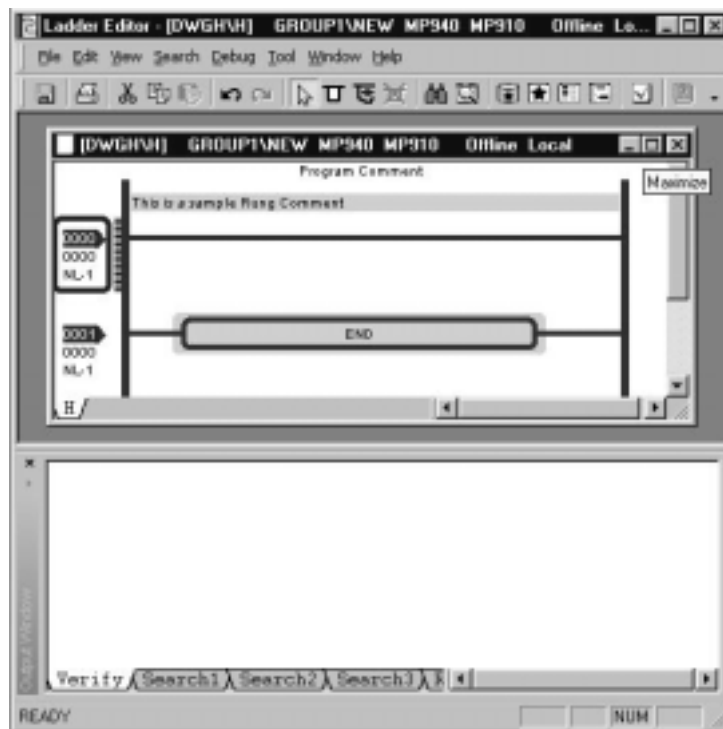

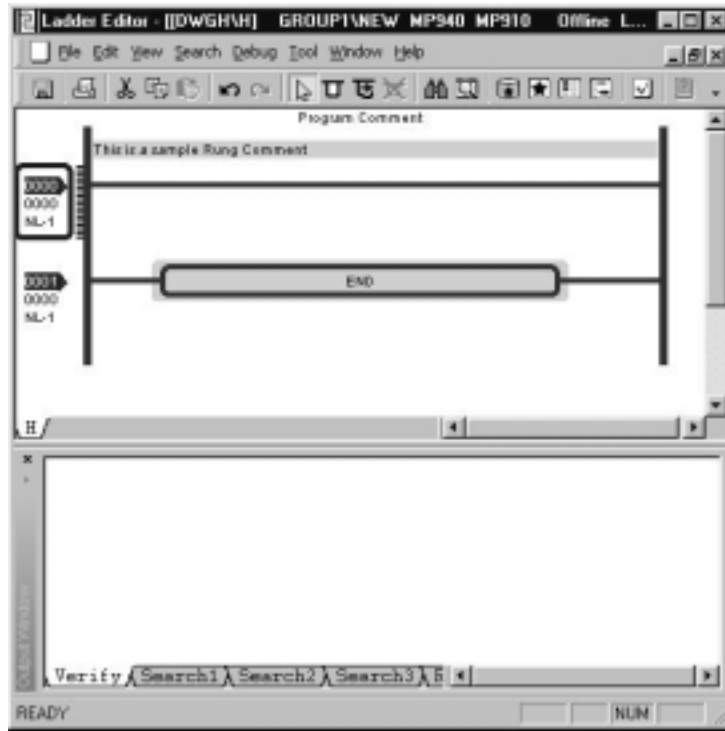
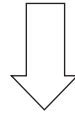

1

## 1.6 TOOL BAR

The main menu in the window operation is displayed as an icon on the toolbar.

### 1.6.1 Display Mode

There are two kinds of display modes for the tool bar.

#### ■ Docked Mode

The toolbar is docked within the frame on the ladder editor.

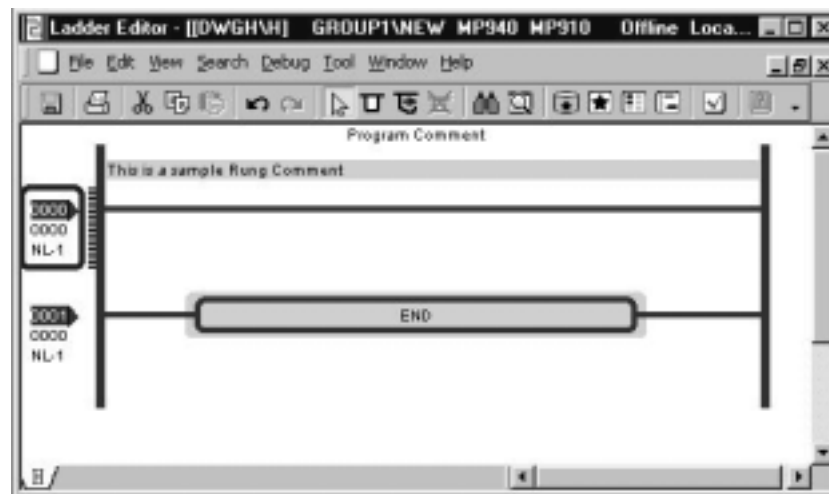

#### ■ Undocked Mode

The toolbar is dragged to any place on the window. Its size is adjusted using the arrows displayed on both sides of the toolbar.

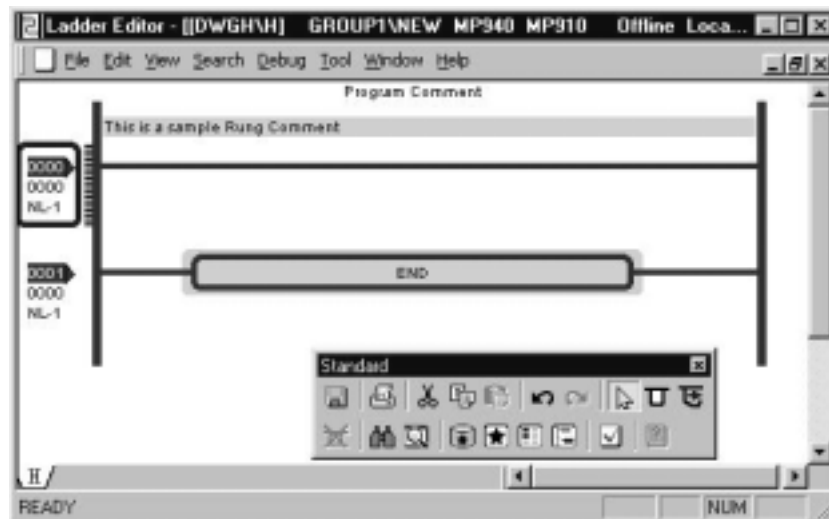



## 1.6.2 Tool Bar Function

When the mouse is located on the icon of the toolbar, its function is displayed. Refer to appendix about the details of each function.

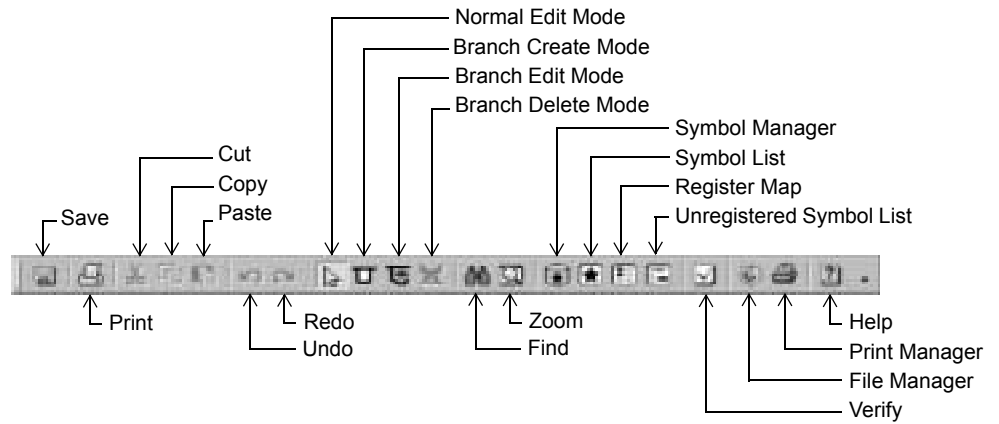

## 1.7 KEYBOARD OPERATION

Keyboard operations are used to make the ladder programming easier.

### 1.7.1 Keyboard Operations on a Rung

#### ■ Cursor Operation

Movement in the program comment, the rung, and between rungs is done with the arrow keys. Jumping to the first program rung is executed by Home key, and jumping to the end rung by End key. Use Ctrl + Home key to jump to the comment in the first program rung.

### 1.7.2 Shortcut Keys

The list of the shortcut keys is shown below.

#### ■ Pull-down Menu

The list of the shortcut keys as well as the pull-down menu items is shown below.

Table 1.1 Pull-down Menu





















Menu (Function)	Shortcut Key
<b>File (F)</b>	
 Save (S)	Ctrl + S
 Print (P)	Ctrl + P
 Exit (N)	Alt + F4
<b>Edit (E)</b>	
 Undo (U)	Ctrl + Z
 Redo (R)	Ctrl + Y
 Cut (T)	Ctrl + X
 Copy (C)	Ctrl + C
 Paste (P)	Ctrl + V
 Delete (D)	Delete
 Insert (I)	Insert
 Add with Branch (A)	Ctrl + Insert
 Insert Rung (I)	Insert
 Insert Rung Comment (U)	Shift + Insert
 Normal Edit Mode (N)	Ctrl + U
 Insert Branch (B)	Ctrl + B
 Branch Insert Mode (B)	Ctrl + I
 Branch Edit Mode (E)	Ctrl + E
 Select All (L)	Ctrl + A
 Verify File (V)	F8
<b>View (V)</b>	
 Editor Options...(E)	Alt + Enter

Table 1.1 Pull-down Menu (cont'd)

Menu (Function)	Shortcut Key
<b>Search (S)</b>	
 Find (F)	Ctrl + F
Replace (P)	Ctrl + H
<b>Window (W)</b>	
Close (C)	Ctrl + F4
Change Focus (F)	Ctrl + F7
Next (X)	Ctrl + F6
<b>Help (H)</b>	
Ladder works Help (H)	F1

### ■ Others

Table 1.2 Other Operation

Function	Shortcut Key
Display the popup menu	Shift + F10
Cancel	ESC
Menu bar mode control	Alt
Enter	Enter
Input of null character in text	Space

---

## PROGRAMMING

This section explains how to edit a program.

<b>2.1 PROGRAMMING</b>	<b>2-3</b>
2.1.1 Object	2-3
<b>2.2 SELECT</b>	<b>2-7</b>
2.2.1 Select Object and Display	2-7
2.2.2 Cursor Operation	2-11
2.2.3 Select Multiple Objects	2-13
2.2.4 Range Selection with Mouse	2-14
<b>2.3 INSERT</b>	<b>2-17</b>
2.3.1 Insert Rung Comment	2-17
2.3.2 Insert Rung	2-18
2.3.3 Insert Instruction	2-20
2.3.4 Insert Branch	2-24
<b>2.4 DELETE</b>	<b>2-26</b>
2.4.1 Delete Rung Comment	2-26
2.4.2 Delete Rung	2-27
2.4.3 Delete Instruction	2-28
2.4.4 Delete Branch	2-29
<b>2.5 BRANCH OPERATION</b>	<b>2-30</b>
2.5.1 Branch Operation Mode	2-30
2.5.2 Create Branch	2-30
2.5.3 Edit Branch	2-32
2.5.4 Delete Branch	2-33
<b>2.6 EDIT CHARACTER STRING</b>	<b>2-34</b>
2.6.1 Edit Character String in the Program Comment	2-34
2.6.2 Edit Character String in the Rung Comment	2-35
2.6.3 Edit Character String in the Instruction	2-36

2.7 EDIT OBJECT	2-44
2.7.1 Edit Single Instruction	2-44
2.7.2 Edit Operand of Instruction	2-49
2.7.3 Edit Multiple Objects	2-52
2.7.4 Undo	2-57
2.7.5 Redo	2-57
2.8 SAVE PROGRAM	2-58
2.8.1 Save	2-58
2.8.2 Save All	2-59
2.9 VERIFY PROGRAM	2-60
2.9.1 Verify	2-60
2.9.2 Verify All Program	2-62

## 2.1 PROGRAMMING

This new ladder editor uses a rung style editing that is different from the original ladder editor. The rung is first specified in a program and then the instruction is placed on it. The location of instruction or the destination of a branch operation is shown so the editing operation such as Cut, Copy, and Paste is easier to use.

### ■ Rules for Rung Style Editing

There are rules to use the rung style editing.

- Insert a rung connected with the left power rail and the right power rail first.
- Insert a branch if the parallel circuit is required.
- Arrange instruction on the rung or the branch.

#### 2.1.1 Object

The operation in the ladder program is defined as the object.

### ■ Objects In the Program Window

There are different kinds of objects in the program window.

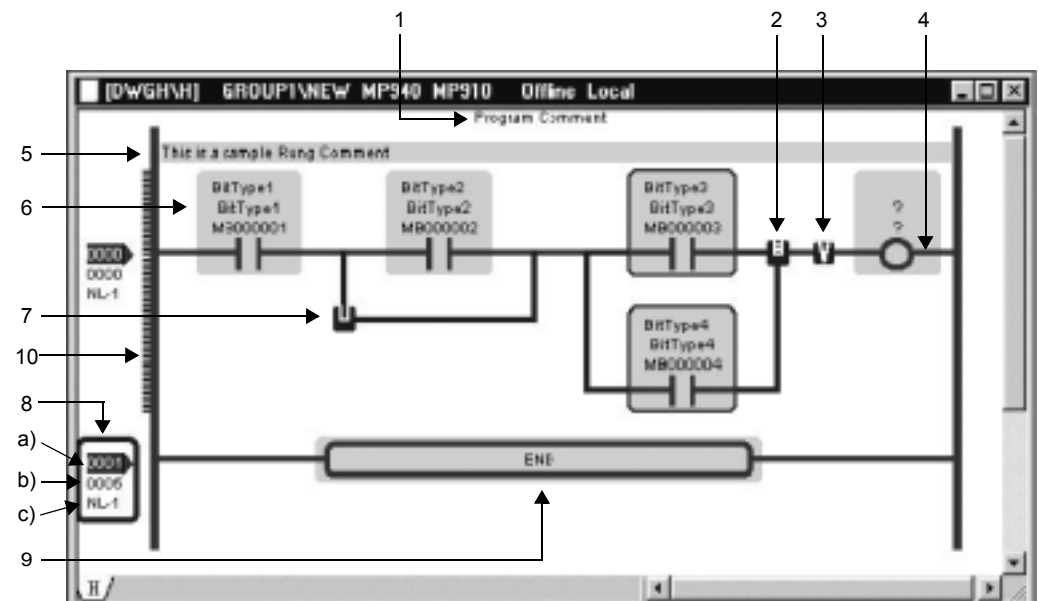

#### 1. Program Comment

This is a comment for the program, and only one per one program window is displayed. The Cut and Delete operation is prohibited.

#### 2. Branch Block

This is a block that two or more branches are located.

3. Cursor

The location where the object is arranged is displayed.

4. Rung

This is basic line that instruction and branch are located on.

5. Rung Comment

This is a comment for a rung. One or more rung comments is available for a rung.

6. Instruction

This is instruction for the ladder editing. It is classified into another kind.

7. Branch

This is a branch that shows the parallel circuit.

8. Rung Left Power Rail

a) Rung Number

The rung number is displayed in order.

b) Step Number

The number of total steps to previous rung is displayed.

c) Nesting Number

The number of nesting is displayed.



The nesting number is increased using IF, FOR, and WHILE instruction.

---

9. END instruction

This instruction is prepared at creating a program automatically.

The Cut and Delete operation is prohibited.

10. Edit Mark

This mark shows the rung edited after the normal termination of verification.

■ Details of Instructions

Relay Type	
	/
Function Block Type	Arithmetic Block Type
<p>Display at Scope OFF</p>	<p>Display at Scope OFF</p>
Program Control Type IF WHILE	Program Control Type EXPRESSION
<p>Display at Scope OFF</p>	<p>Display at Scope OFF</p>
Instruction including a text in a operand [Table Instruction]	User Function FUNC
<p>Display at Scope OFF</p>	<p>Display at Scope OFF</p>

2



1. Comment for a address or instruction  
The comment for a address or instruction is displayed and can be set.
2. Symbol  
The symbol of instruction is displayed and can be set.
3. Address  
The address of register is displayed and can be set.
4. Instruction Name  
The instruction name or instruction diagram is displayed.
5. Button for Scope  
The display format is changed by scope ON and OFF operation
6. Conditional Expression  
The conditional expression is displayed and can be set.
7. Arithmetic Expression  
The arithmetic expression is displayed and can be set.
8. String  
The specified string such as the table name is displayed and can be set.
9. User Function Name  
The user function name is displayed and can be set.

### Category of Instruction

The main instruction displayed in the ladder program window is the following eleven classifications.

- RELAY
- MATH
- LOGIC
- CONTROL
- FUNCTION
- MOVE
- DDC
- TABLE
- SYSTEM
- SFC
- MOTION

Refer to the instruction manual for full details.

## 2.2 SELECT

There are two kinds of way to select the objects.

- Click the specified location using the mouse.
- Select the specified location by moving the cursor in the program with the arrow keys.

The selected object is highlighted with a specified color line (The default color is blue).

### 2.2.1 Select Object and Display

#### ■ Program Comment

<Selection Method>: Select the display area of a program comment.

<Display>



#### ■ Rung Comment

< Selection Method >: There are three kinds of selection as follows.

<Display>

Out of the Left Power Rail



Display Area



Comment Input Mode

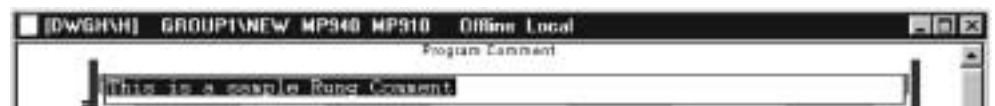

#### ■ Rung

< Selection Method >: Select the rung number.

< Display >



■ Instruction

< Selection Method >: Select the display area of the instruction name of the instruction. The instruction is highlighted with a blue line when selected.

< Display >



■ Branch

< Selection Method >: Select the junction of the branch.

The instruction on a branch is selected and a branch is not selected.

< Display >

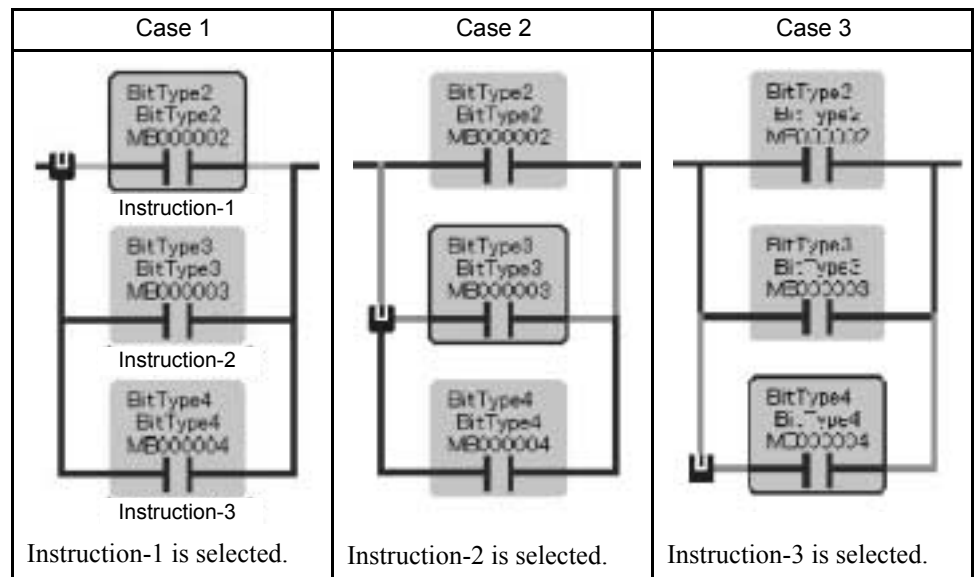

## ■ Branch Block

< Selection Method >: Select the joint of the branch block.

The instruction on a branch is selected with a branch.

< Display >

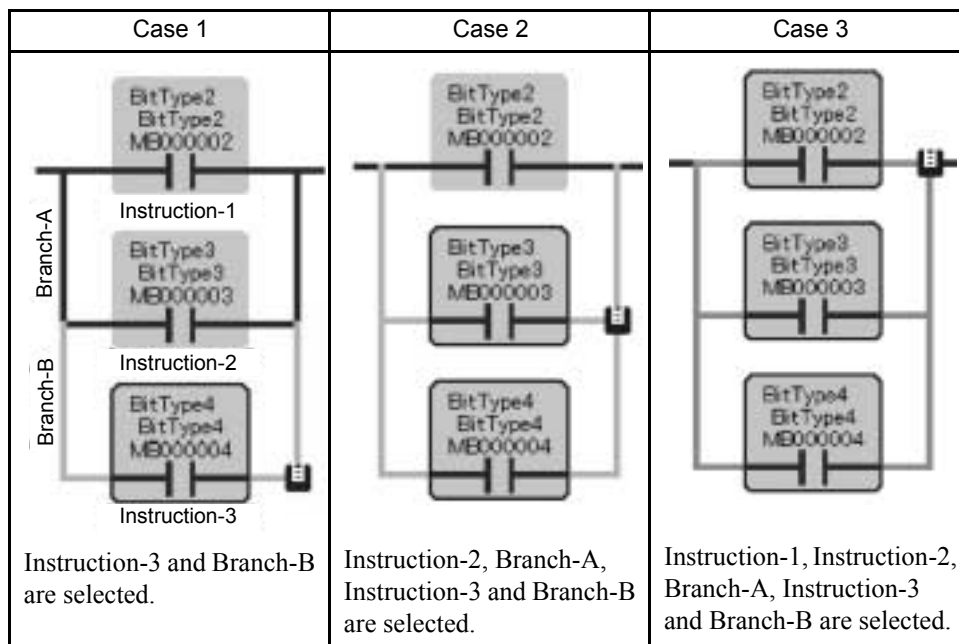

## ■ Comment

< Selection Method >: Select the display area of the comment of the instruction. The instruction is highlighted with a blue line when selected.

< Display >



### ■ Symbol

< Selection Method >: Select the display area of the symbol of the instruction. The instruction is highlighted with a blue line when selected.

< Display >



### ■ Address

< Selection Method >: Select the display area of the address of the instruction. The instruction is highlighted with a blue line when selected.

< Display >



### ■ Instruction Name

< Selection Method >: Select the display area of the instruction name of the instruction. The instruction is highlighted with a blue line when selected.

< Display >



## 2.2.2 Cursor Operation

### ■ Example of Down Arrow Key Operation

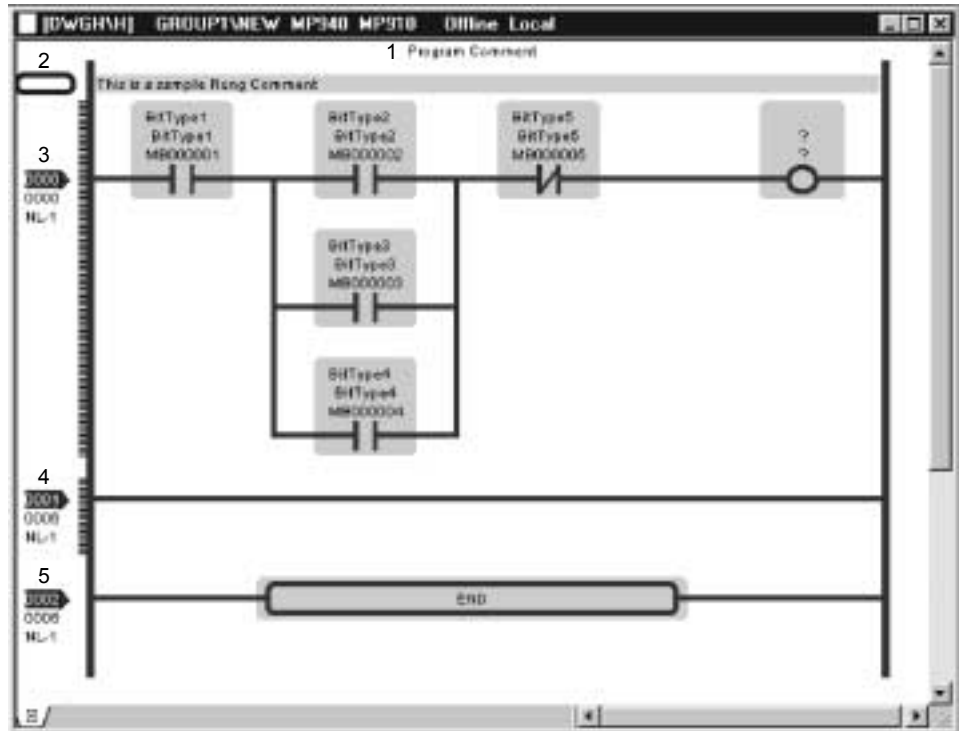

2

The cursor moves in the following order when the down arrow key is selected in this example.

1. Program comment
2. Rung comment located out of the left power rail
3. Rung number 0
4. Rung number 1
- :
5. Rung number n



The cursor moves in the opposite direction, if up arrow key is selected.

### ■ Example of Right Arrow Key Operation

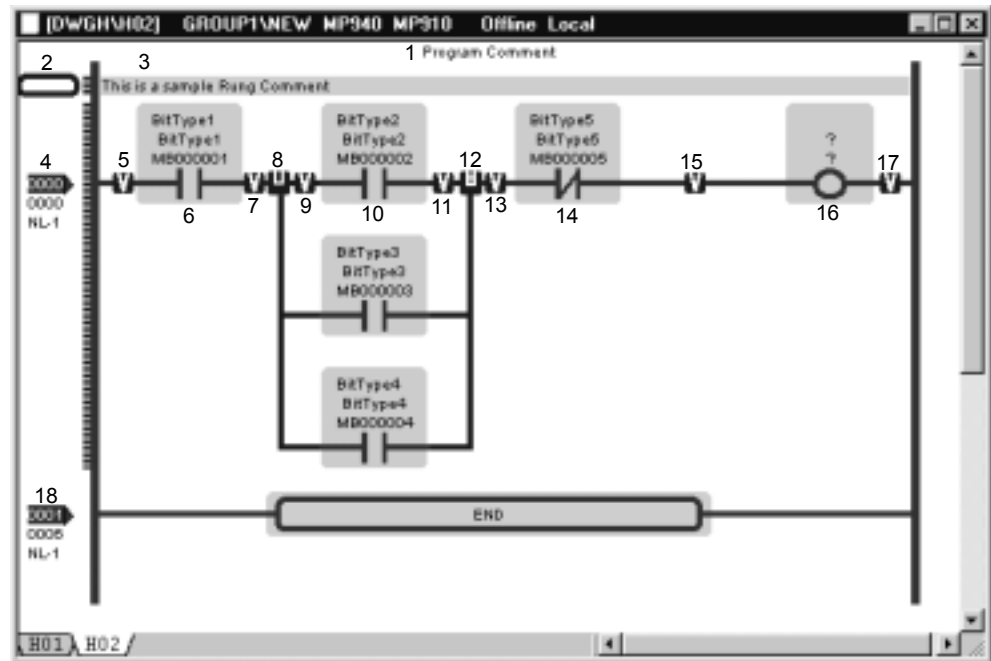

The cursor moves in the following order when the right arrow key is selected in this example.

1. Program comment
2. Rung comment located out of the left power rail
3. Rung comment
4. Rung number 0
5. Insert location on a rung
6. Instruction
7. Insert location on a rung
8. Junction of branch
9. Insert location on a rung
10. Instruction
11. Branch Block Instruction
12. Joint of branch
13. Insert location on a rung
14. Other instruction
15. Insert location on a rung
16. Other instruction
17. Insert location on a rung
18. Rung number 1

Select the down arrow key, if the cursor moves to the under at 8.

## 2.2.3 Select Multiple Objects

There are three kinds of multiple object selections.

### ■ Select Objects in Continuous Range

- Select two objects away with the Shift key pushed with the mouse.

The object selected first is the beginning point, and the object selected next is the ending point, and then all object are selected between them in continuous range.



---

<Key Operation>: Shift + Arrow Key

---

2

### ■ Select Objects in Non-Continuous Range

- Select two or more objects away with the Ctrl key pushed with the mouse.

The specified objects in non-continuous range are selected.



---

<Key Operation>: Ctrl + Arrow Key (decided by Enter Key)

---

### ■ Select All Object

- Select *Edit (E) - Select ALL (L)*.

All objects except the program comment and END instruction are selected.



---

<Key Operation>: Ctrl + A Key

---



### 2.2.4 Range Selection with Mouse

Multiple consecutive objects can be selected by enclosing the objects with mouse's drag. Move the mouse with the mouse button pushed from the starting point within the range of the selection, a dotted line rectangle which shows the range of the selection is displayed, and the selected objects are changed into blue. (The instruction is surrounded with a blue line and the line of a branch changes blue) The rectangle disappears when the mouse button is released in the terminal within the range of the selection, and the selection operation ends.

#### ■ Single Object Selection

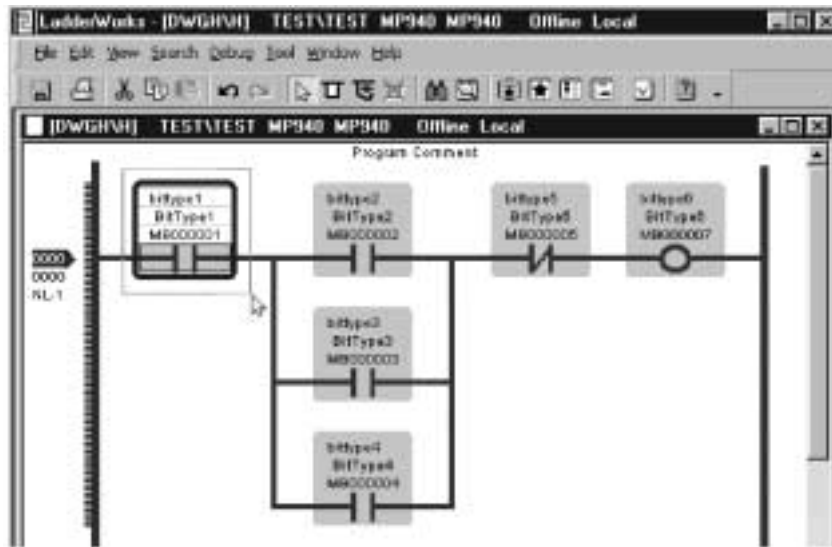

#### ■ Multiple Objects Selection

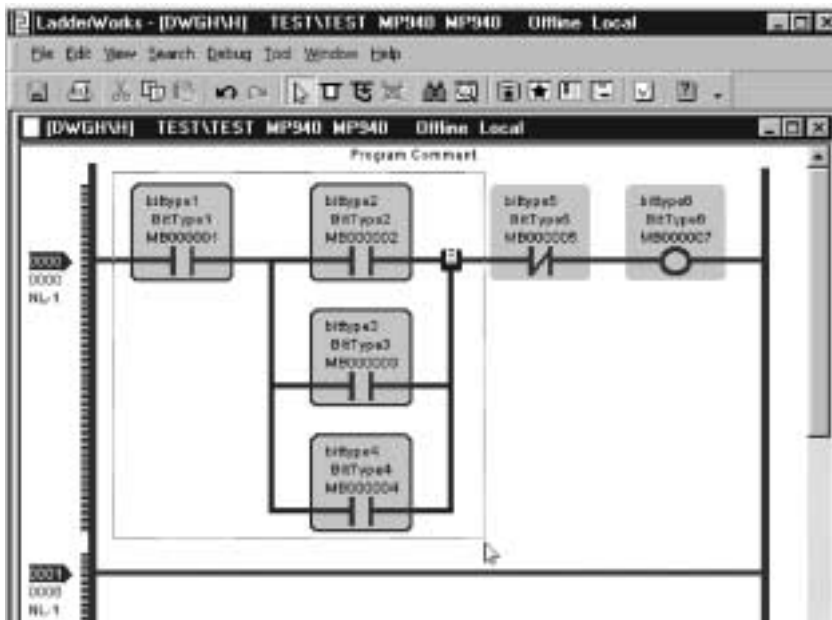

## ■ Precantions At Range Selection

In range selection of the object containing a branch with a mouse, be careful of the following points.

A Branch is not selected although the instruction on a branch is selected.

< Selection Method >: Select the junction of the branch.

The instruction on a branch is selected and a branch is not selected.

< Display >

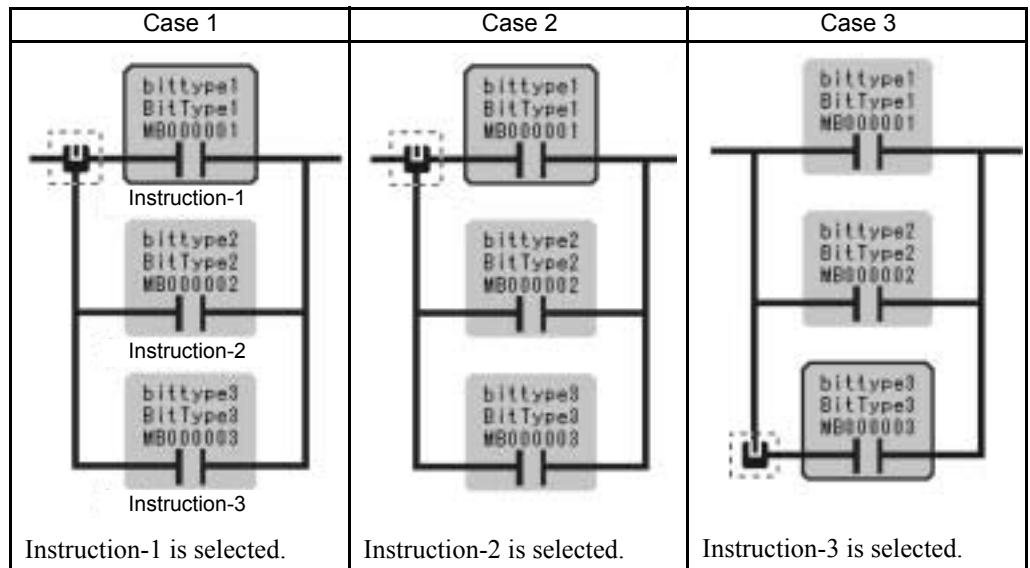

A Branch and the instruction on a branch are selected.

< Selection Method >: Select the joint of the branch block.

The instruction on a branch is selected with a branch.

< Display >

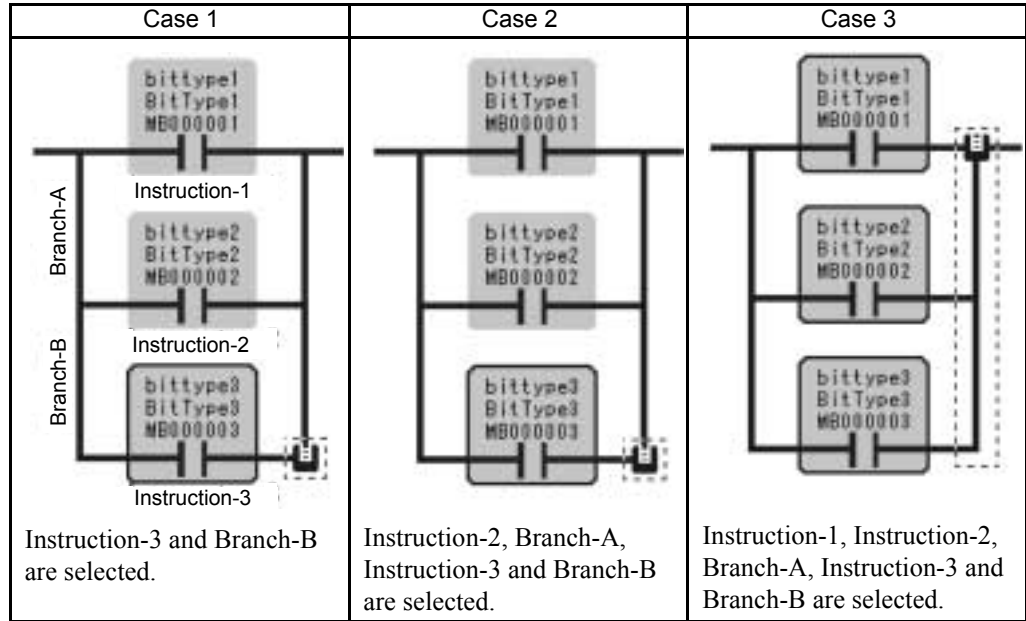

## 2.3 INSERT

The Insertion of the rung comment, rung, instruction, and branch is explained.

### 2.3.1 Insert Rung Comment

1. Select the rung number where the rung comment is newly inserted, and select **Edit (E) - Insert Rung Comment (U)** of the menu or from the pop menu.



<Key Operation>: Shift + Insert

2

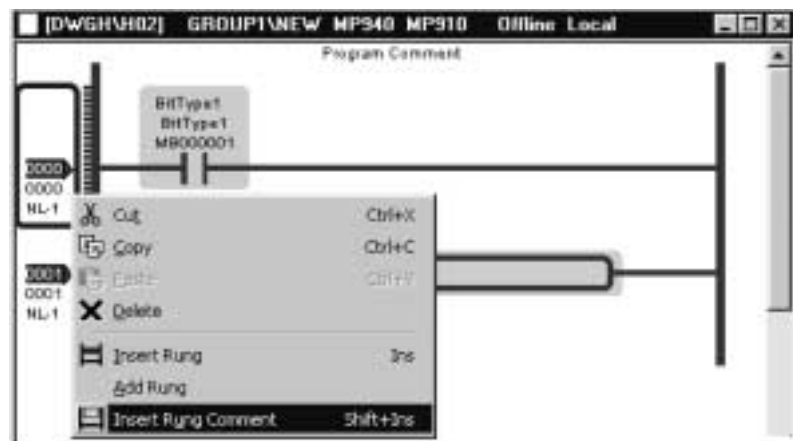

2. A new rung comment is displayed at a specified position.

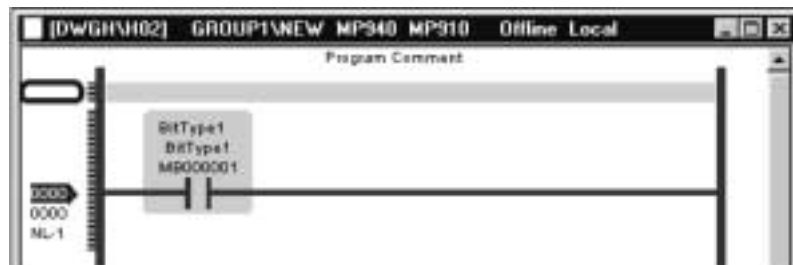

## 2.3.2 Insert Rung

### ■ Insert before selected Rung

1. Select the rung position newly inserted and select **Edit (E) - Insert Rung (I)** of the menu or from the pop menu.



<Key Operation>: Insert key at a specified position.

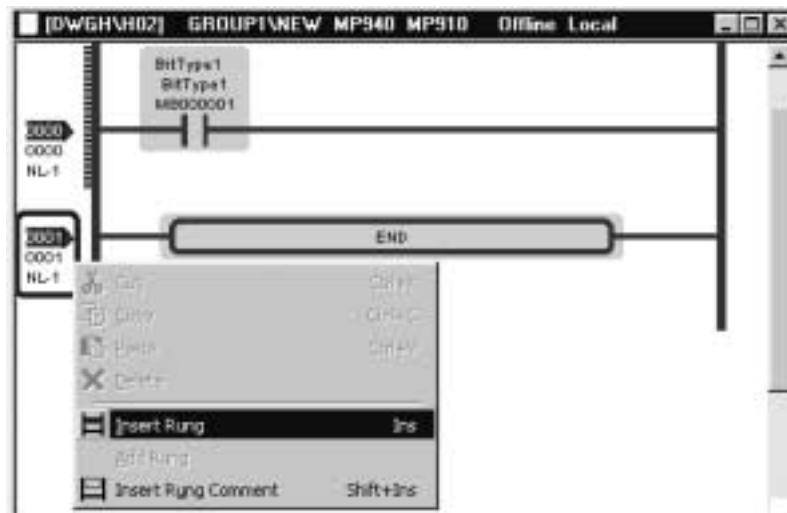

2. A new rung is displayed at a specified position.

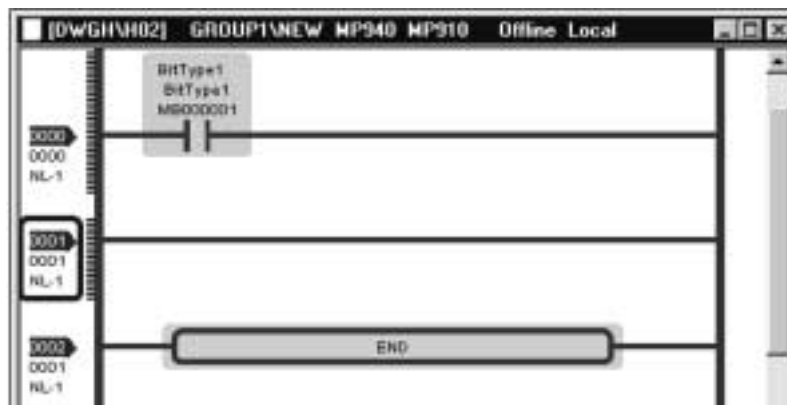

## ■ Insert after selected Rung

1. Select the rung position newly inserted and select **Edit (E) - Add Rung (A)** of the menu or from the pop menu.

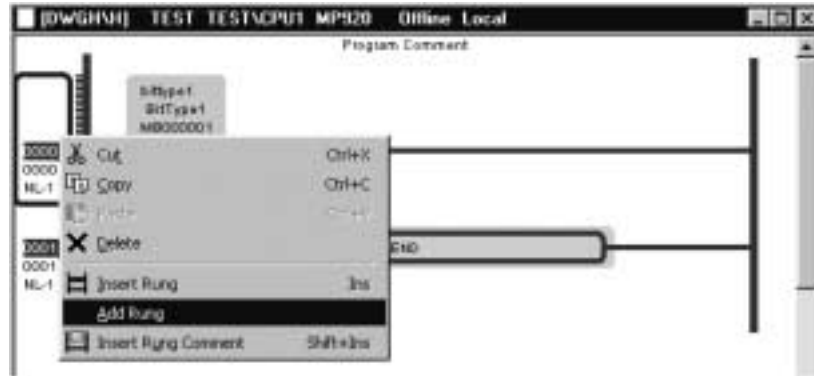

2. A new rung is displayed at a specified position.

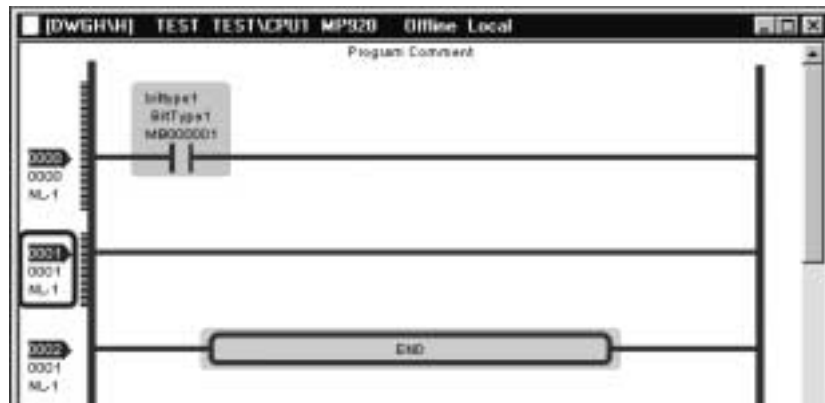

### 2.3.3 Insert Instruction

There are four kinds of instruction selection as follows.

- Select the icon on the instruction palette and insert it to program
- Drag and drop the icon on the instruction palette and insert it to program
- Select Mnemonic Operation by shortcut command
- Select the menu or the pop-up menu

#### ■ Select the icon on the instruction palette

1. Click the instruction inserted on the instruction palette.

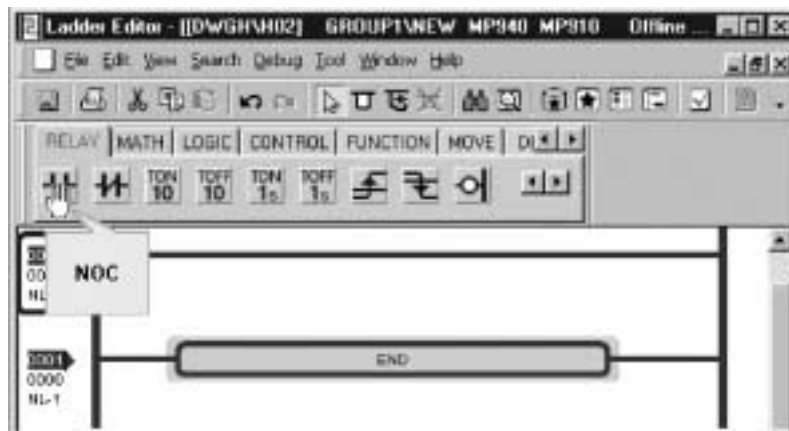

2. The selected instruction icon is displayed in the active status.



3. When the mouse pointer is brought close on the rung in the program, the guide mark ("V") for insertion is displayed at the position where the instruction can be arranged.

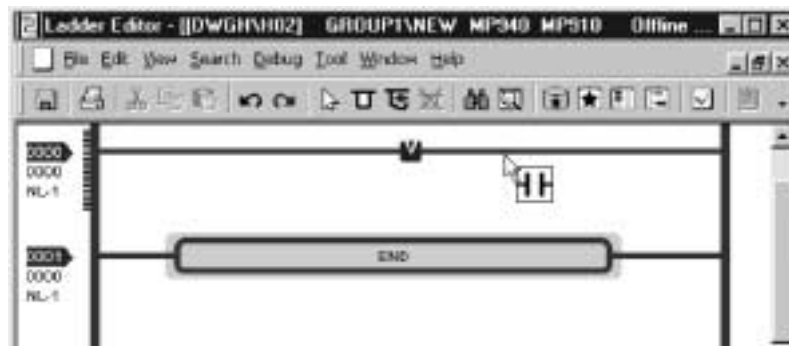

4. The selected instruction is inserted when clicking at the guide mark.

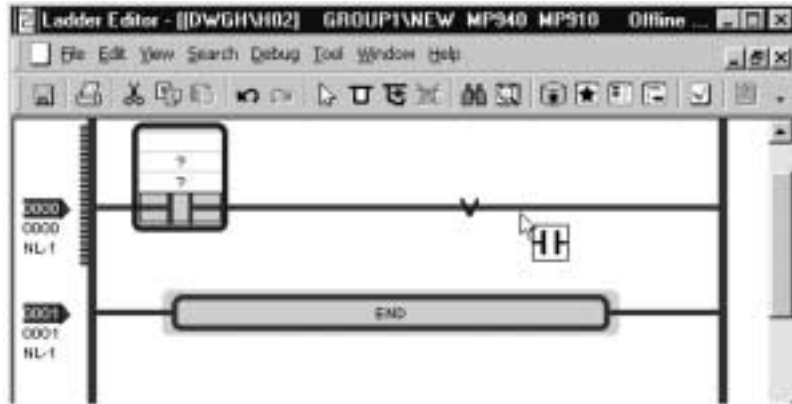

2

5. The same instruction can be inserted continuously during the icon on the instruction palette is in the active status.

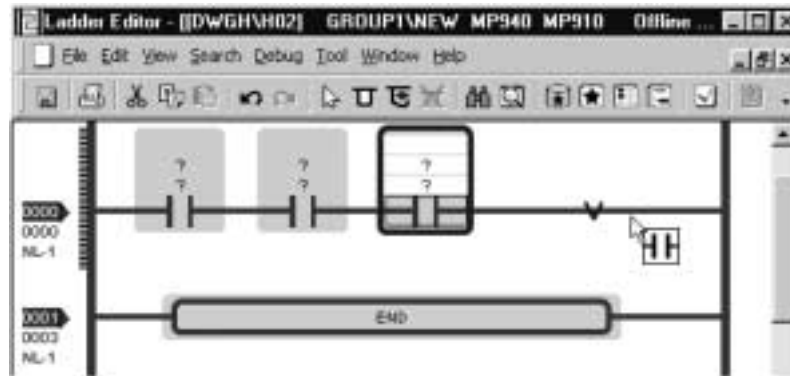

6. The icon on the instruction palette in the active status is turned off by clicking the icon again, or right-click in the program window.



<Key Operation>: Esc



### ■ Drag and drop the icon on the instruction palette

1. Click the instruction inserted on the instruction palette.
2. When it is dragged as it is on the rung in the program, the guide mark ("V") for insertion is displayed at the position where the instruction can be arranged. The cursor is displayed in the dragging.

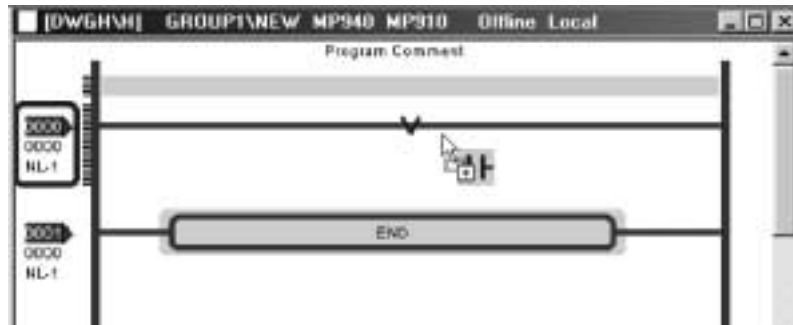

3. The instruction inserted on the rung is displayed.

Note: The insertion operation by Drag & Drop is only once. The icon on the instruction palette is in the non-active status.

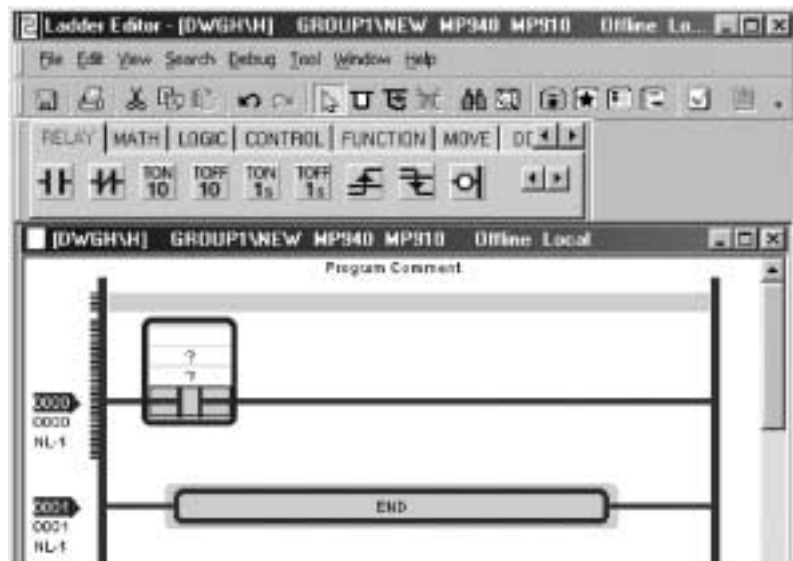

## ■ Select mnemonic operation by shortcut command

1. Click somewhere on the rung and the operation mode is changed into insert mode.

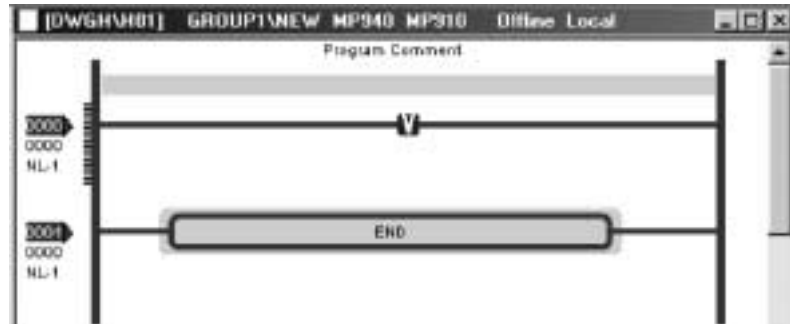

2. Input the mnemonic that is called as shortcut command from the keyboard, and enter it.

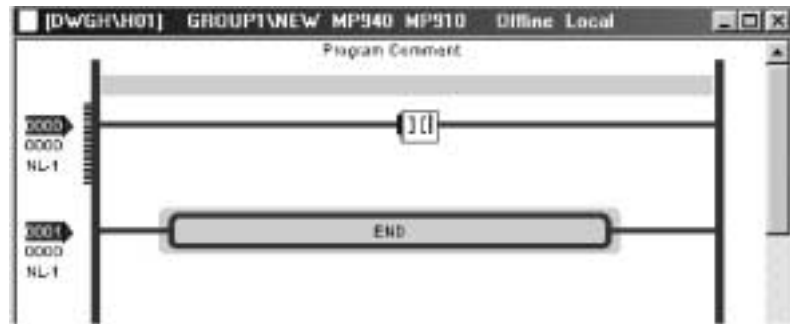

3. The input instruction is displayed.

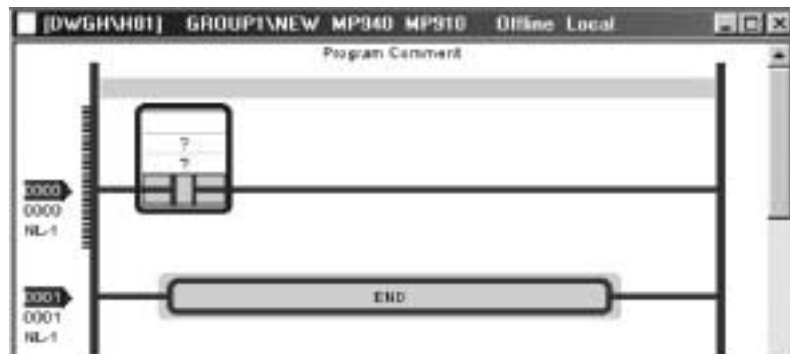

Refer to the operation manual about the mnemonic.

## ■ Select the menu or the pop-up menu

The instruction can be inserted from menu or pop-up menu.

Please refer to 2.7.1 "Edit Single Instruction" for details.

## 2.3.4 Insert Branch

1. Select **Edit (E) - Branch Insert Mode (B)** of the menu or Click the Branch Insert Mode button on the toolbar.



<Key Operation>: Ctrl + I



2. When the mouse pointer is brought close on the rung in the program, the guide mark ("V" mark) for insertion is displayed at the position where the branch can be inserted on the rung and the cursor is changed into the branch insert mode.

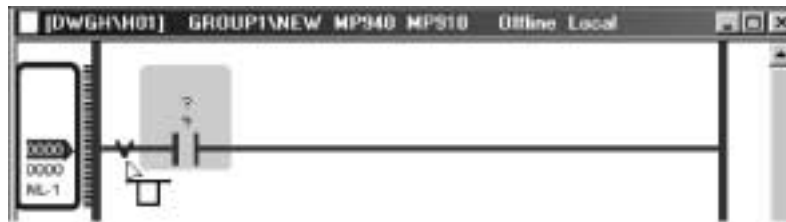

3. Select the guide mark ("V" mark) as the beginning point and move the cursor to the right direction on the rung. The guide mark ("V" mark) is displayed at the position as the ending point.

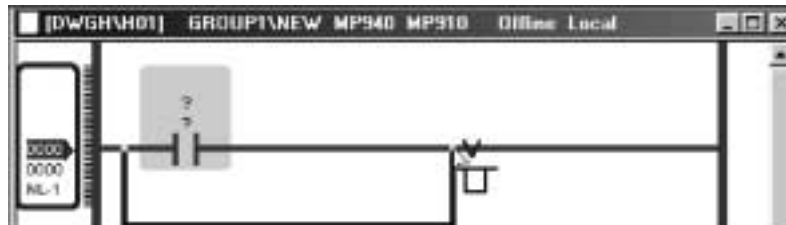

4. Click the guide mark and complete to insert the branch on the rung.

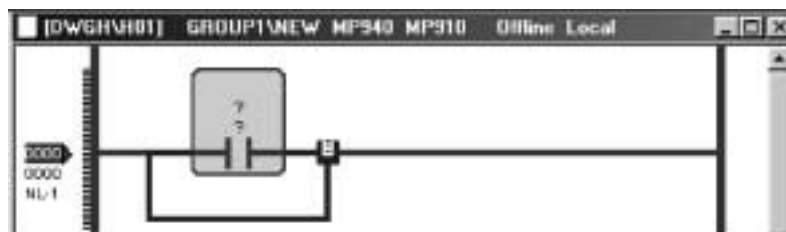

5. Click the following insertion beginning position when the branch is continuously inserted. It is possible to insert branch continuously during the insert mode is selected.

6. It is possible to turn off the branch insert mode by clicking the icon on the toolbar or by right-click on the branch.



---

<Key Operation>: Esc

---

## 2.4 DELETE

The deletion of the rung comment, the rung, the instruction, and the branch is explained.

### 2.4.1 Delete Rung Comment

1. Select the deleted rung comment, and select **Edit (E) - Delete (D)** of the menu or from the pop menu.



<Key Operation>: Delete

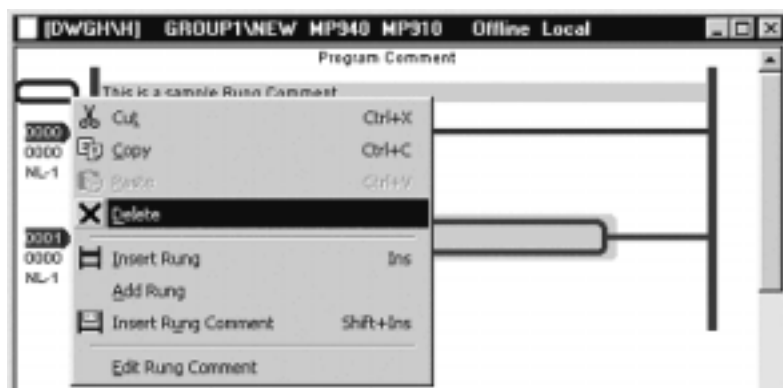

2. The selected rung is deleted.

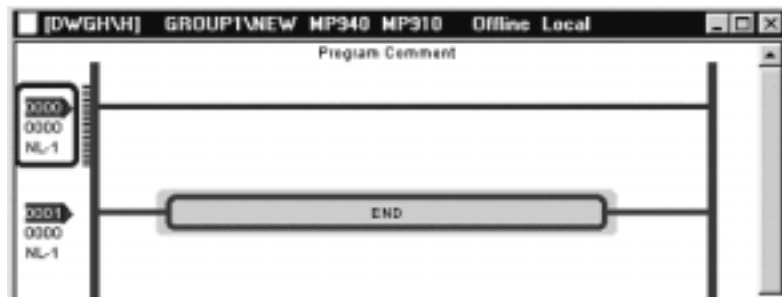

## 2.4.2 Delete Rung

1. Select the deleted rung number and select **Edit (E) - Delete (D)** of the menu or from the pop menu.

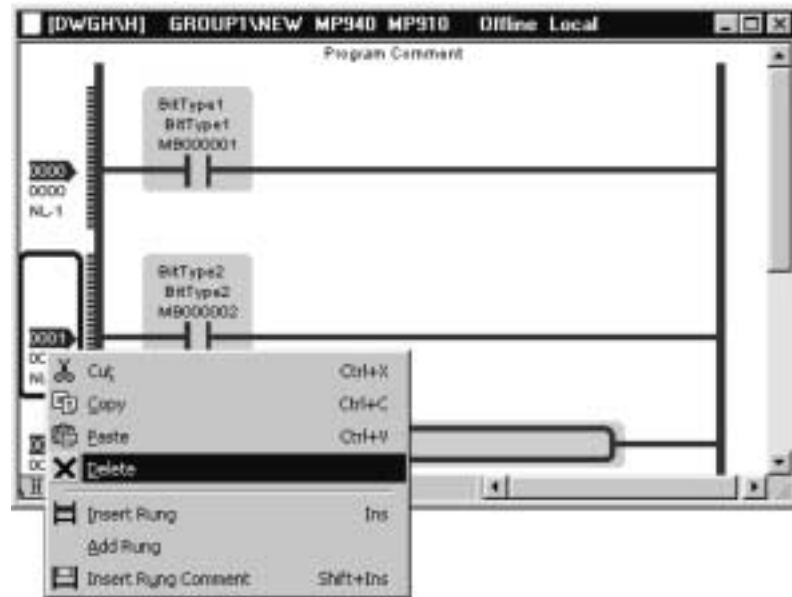

2. The selected rung is deleted and the cursor is moved to next rung.

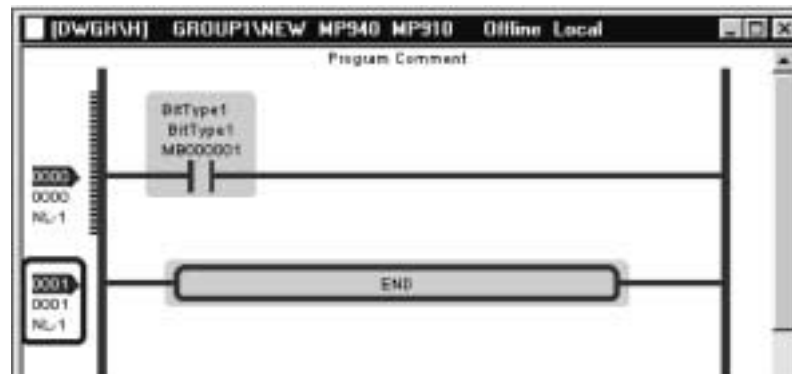

1. <Key Operation>: Delete
2. The rung for the END instruction cannot be deleted.

### 2.4.3 Delete Instruction

1. Select the instruction name of the deleted instruction, and select *Edit (E) - Delete (D)* of the menu or from the pop-up menu.



<Key Operation>: Delete

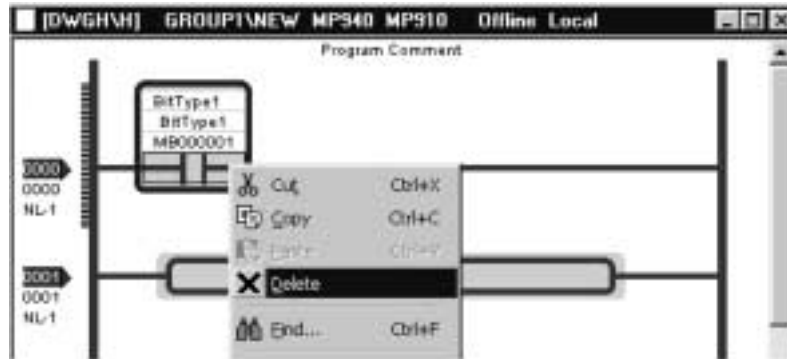

2. The instruction is deleted and the object on the right side becomes selected. If there is no instruction on the rung, the cursor is displayed there.

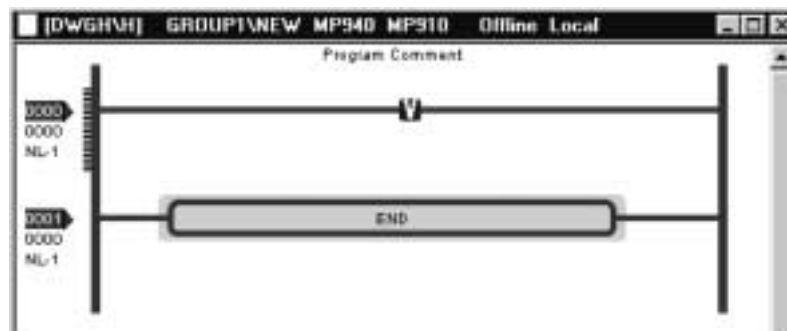

## 2.4.4 Delete Branch

1. Select the junction of the deleted branch and select **Edit (E) - Delete (D)** of the menu or from the pop-up menu.



<Key Operation>: Delete

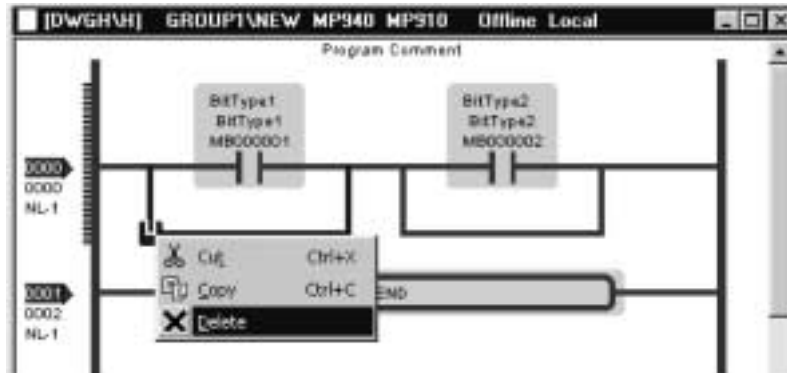

2. The selected branch is deleted.

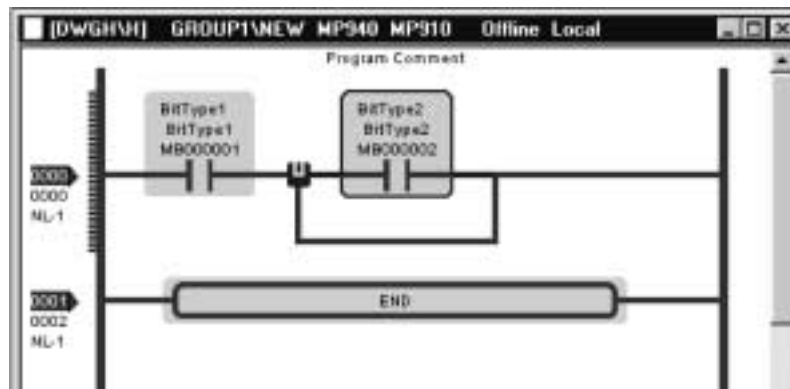



## 2.5 BRANCH OPERATION

### 2.5.1 Branch Operation Mode

Change the edit mode from a normal edit mode to the branch operation modes. There are four kinds of the edit mode as follows.

- Normal Edit Mode

It is the default mode.

The insert, delete, and edit of the instruction in the program are available.



<Key Operation >: Ctrl + U from other modes

---

- Branch Create Mode

It is the mode to create a branch in the program.

The new branch is created for the selected guide mark position



<Key Operation >: Ctrl + I from other modes

---

- Branch Edit Mode

It is the mode to edit a branch in the program.

The junction or the joint of the selected branch is changed to the other position.



<Key Operation >: Ctrl + E from other modes

---

- Branch Delete Mode (Supported in the future)

It is the mode to delete a branch in the program.

All instructions on the branch are deleted together.



<Key Operation >: Ctrl + D from other modes

---

### 2.5.2 Create Branch

The creating a new branch by shortcut key operation is explained. Please refer to 2.3.4 Insert Branch about the mouse operation.

1. Input the Ctrl + I from the keyboard. The branch insert mode icon on the toolbar becomes active.



The branch insert mode mouse pointer is displayed.



2. Move the cursor to the beginning point of branch on the rung and press the Enter key.

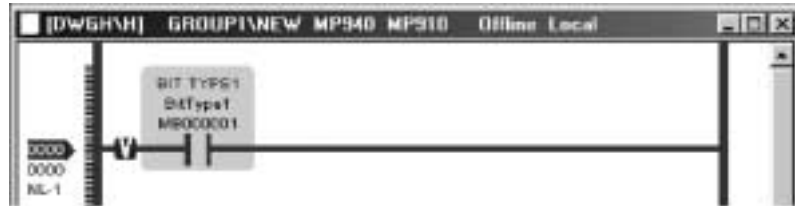

3. The end point of the branch is then selected.



4. Move the cursor to the end point of the branch.

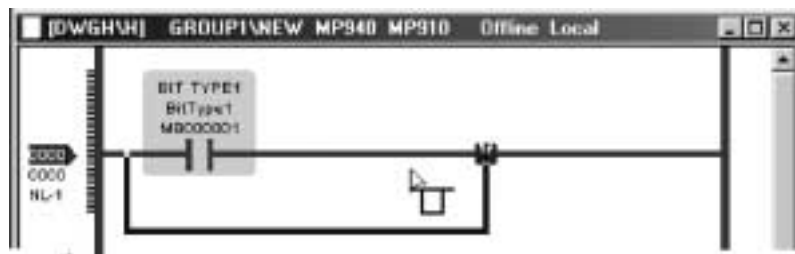

5. The new branch is displayed when the Enter key is pressed.

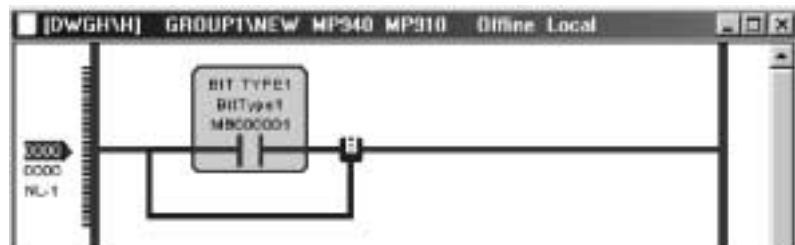

Normal edit mode is selected by the Ctrl + U.

## 2.5.3 Edit Branch

Changing the branch by shortcut key operation is explained. The junction or the joint of the selected branch is changed to the other position.

1. Input the Ctrl + E from the keyboard. The branch edit mode icon on the toolbar becomes active.



The branch edit mode mouse pointer is displayed.



2. Move the cursor to the changed point on the branch, and press the Enter key. It can be changed to other point.

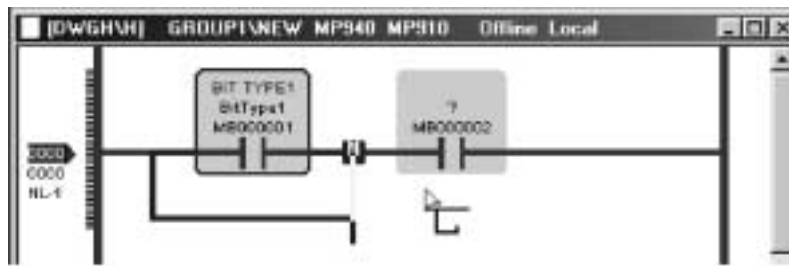

3. Move the cursor to the new point on the rung. The branch is displayed in the light color while the cursor is moving.

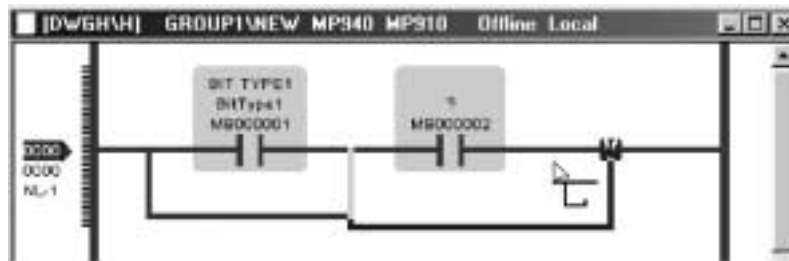

4. Decide the new point by pressing the Enter key.

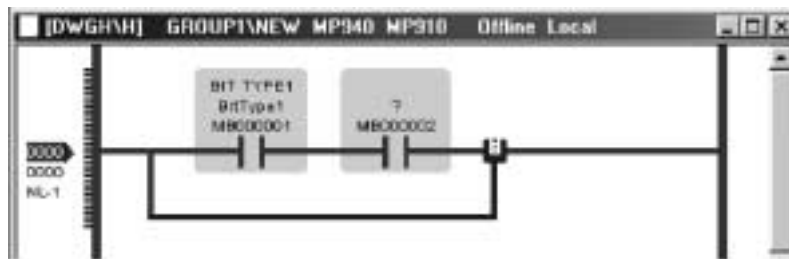

Normal edit mode is selected by the Ctrl + U.

## 2.5.4 Delete Branch

Deleting a branch is explained. Please refer to 2.4.4 "Delete Branch" about the mouse operation.

1. Select the branch to be deleted with the mouse. The branch is changed into the selection mode.



The toolbar and the shortcut key operation are not prepared now.



2. Input the Delete key from the keyboard.
3. The selected branch is deleted.

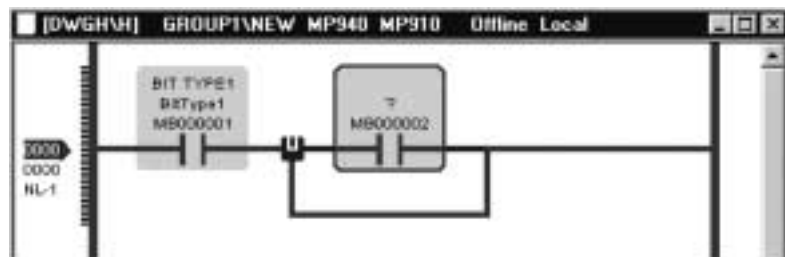

## 2.6 EDIT CHARACTER STRING

Editing of a character string in the program window is explained.

### 2.6.1 Edit Character String in the Program Comment

1. Select the program comment at the top area of the program window and select **Edit (E) - Edit Program Comment (G)** of the menu or from the pop-up menu.

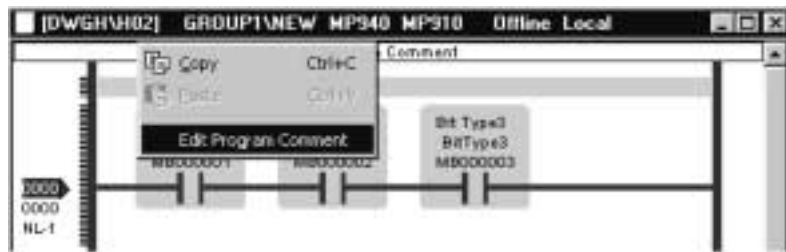

2. The program comment area is displayed in the edit mode. Input the new program comment character string and press the Enter key.

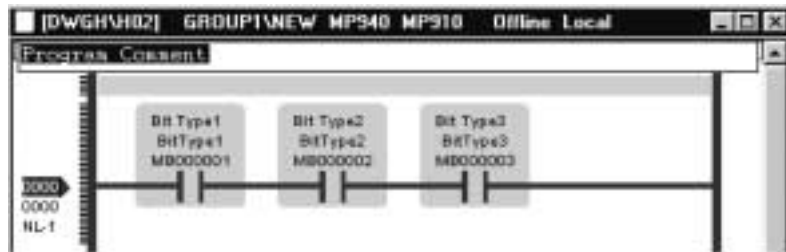

3. The new program comment is displayed.

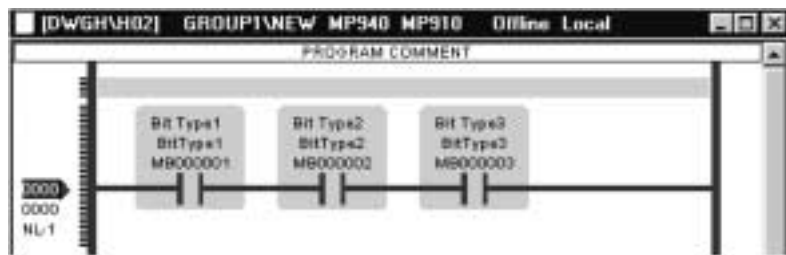

Changing lines in the edit mode is possible by Ctrl + Enter.

## 2.6.2 Edit Character String in the Rung Comment

1. Select a rung comment in the program window and select **Edit (E) - Edit Rung Comment (E)** of the menu or from the pop-up menu.



<Key Operation>: F2

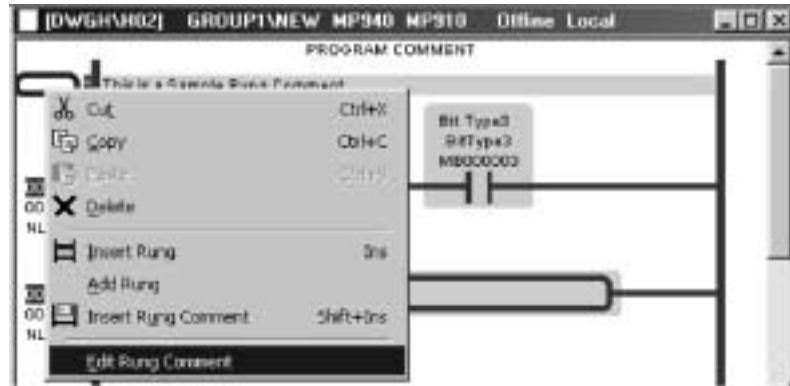

2. The rung comment is displayed in the edit mode. Input the character string for the rung comment and press the Enter key.

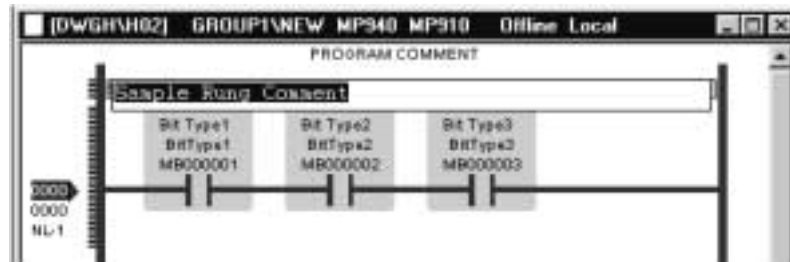

3. The new rung comment is displayed.

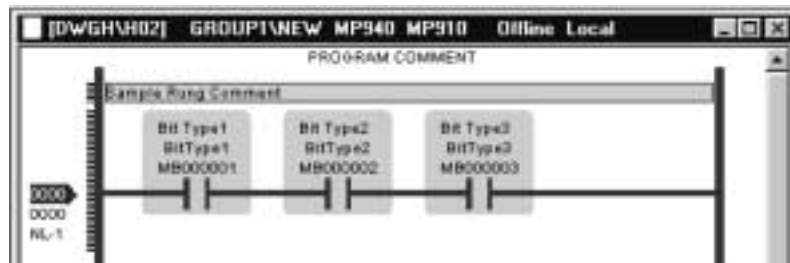





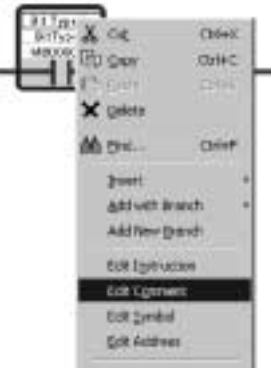

Changing lines in the edit mode is possible by Ctrl + Enter.

### 2.6.3 Edit Character String in the Instruction

#### ■ Edit Character String of Comment

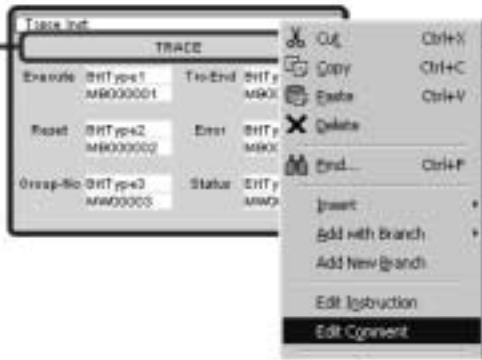
1. Select the comment and select **Edit (E) - Edit Comment (O)** of the menu or from the pop-up menu, or double-click the comment in the instruction.
2. The selected comment is changed into the edit mode and it is possible to be edited.

	Menu	Edit Mode
Relay Type		
Arithmetic Type Block Type		
Function Type Block Type		

	Menu	Edit Mode
Program Control Type		

2

■ Edit Character String of Address

1. Select the address and select **Edit (E) - Edit Address (E)** of the menu or from the pop-up menu, or double-click the address in the instruction.



<Key Operation>: F2

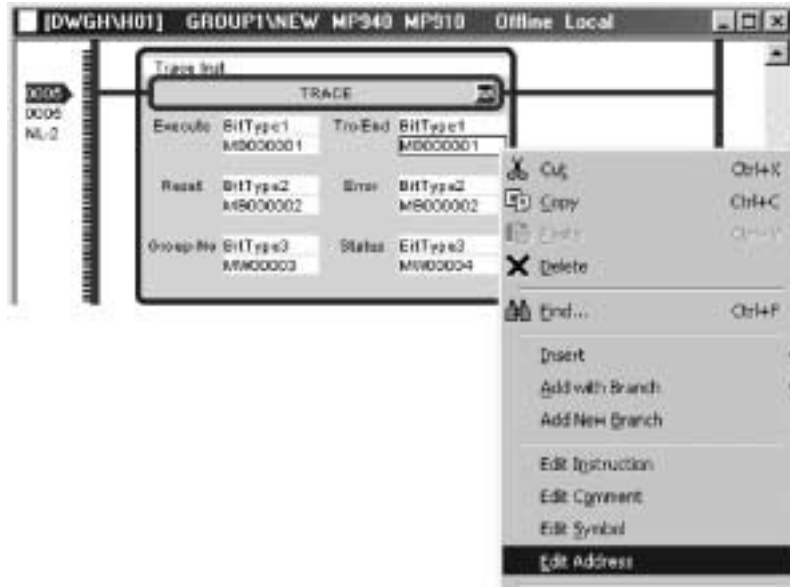

2. The selected address is changed into the edit mode and it is possible to be edited.







When immediate data is input to the address, the same data is input to the symbol.

### ■ Edit Character String of Symbol

1. Select the symbol and **Edit (E) - Edit Symbol (S)** of the menu or from the pop-up menu, or double-click the symbol in the instruction.



<Key Operation>: F2



2. The selected symbol is changed into the edit mode and it is possible to be edited.

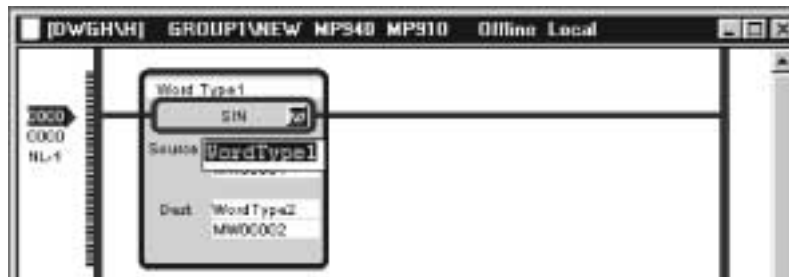

1. It is necessary to register the symbol for new registration of the instruction.
2. When immediate data is input to the symbol, the same data is input to the address.

## ■ Edit Character String of Instruction Name

1. Select the instruction name and select **Edit (E) - Edit Instruction (N)** of the menu or from the pop-up menu, or double-click the instruction name in the instruction.



<Key Operation>: F2



2

2. The selected instruction name is changed into the edit mode and it is possible to be edited. Input the instruction name by mnemonic key.



### ■ Edit Peculiar Character String of Object

In the operand of the instruction, there is something that contains the character string such as TABLE instruction besides the symbol, the address, and the comment.

1. Select the peculiar character string and select **Edit (E) - Edit String (E)** of the menu or from the pop-up menu, or double-click the peculiar character string in the instruction.



<Key Operation>: F2



2. The selected character string is changed into the edit mode, and it is possible to be edited.

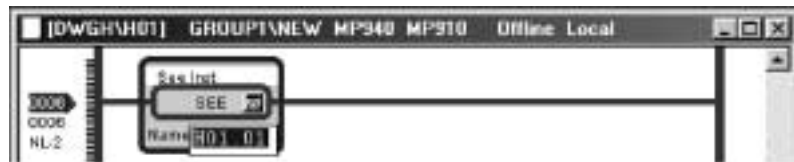

## ■ Edit Character String of User Function Name

FUNC that is the user function instruction has the user function name as data.

1. Select the user function name and select **Edit (E) - Edit User Function (E)** of the menu or from the pop-up menu, or double-click the user function name in the instruction.



<Key Operation>: F2

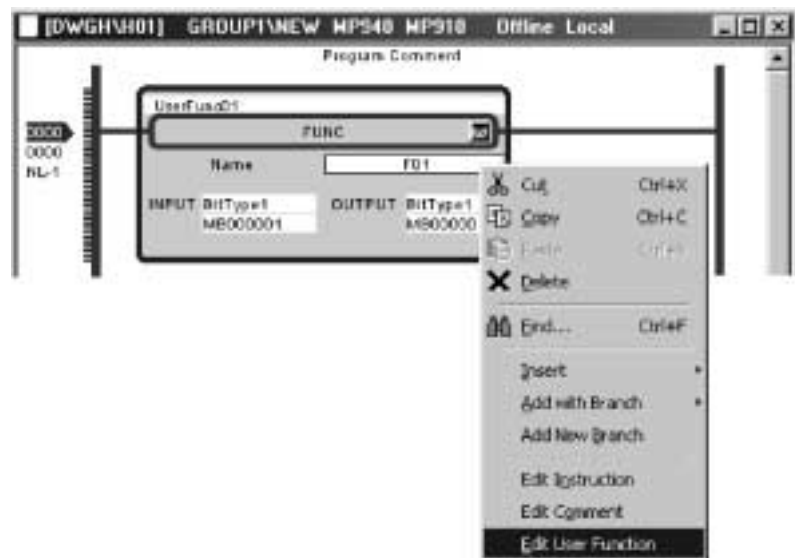

2. The selected user function name is changed into the edit mode, and it is possible to be edited.

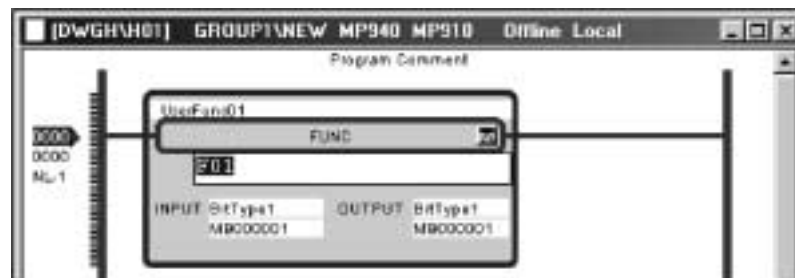

## ■ Edit Character String of Conditional Expression

As for IF and the WHILE instruction, the operand contains the conditional expression.

1. Select the operational expression and select **Edit (E) - Edit Conditional Expression (E)** of the menu or from the pop-up menu, or double-click the conditional expression in the instruction.



<Key Operation>: F2

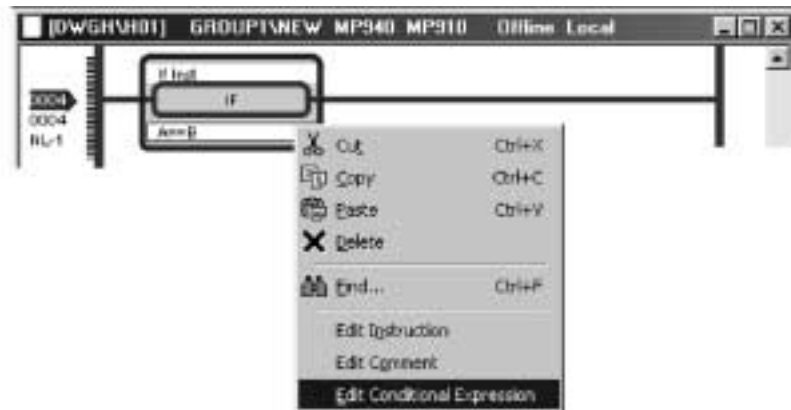

2. The conditional expression by which the result of a Boolean type is output can be described only by one line.



## ■ Edit Character String of Operational Expression

As for the EXPRESSION instruction, the operand contains the operational expression.

1. Select the EXPRESSION instruction and select **Edit (E) - Edit Operational (E)** of the menu or from the pop-up menu, or double-click the operational expression in the instruction or double-click the operational expression in the instruction.



<Key Operation>: F2



2. The description by C language becomes possible.

Changing line in the arithmetic expression area is possible by Ctrl + Enter.

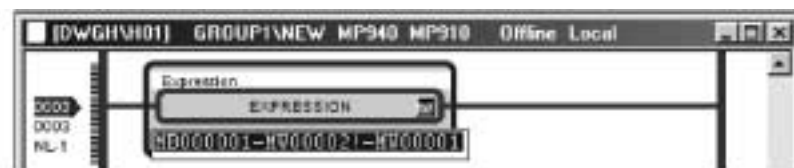

## 2.7 EDIT OBJECT

### 2.7.1 Edit Single Instruction

#### ■ Insert Instruction

1. Select the guide mark on the rung and select **Edit (E) - Insert (I)** of the menu or from the pop-up menu by the right-click.



<Key Operation>: Insert

- From the pop-up menu of instruction



- From the pop-up menu between objects



2. The selected instruction is inserted.



## ■ Delete Instruction

1. Select the deleted instruction and select **Edit (E) - Delete (D)** of the menu or from the pop-up menu by the right-click.



<Key Operation>: Delete

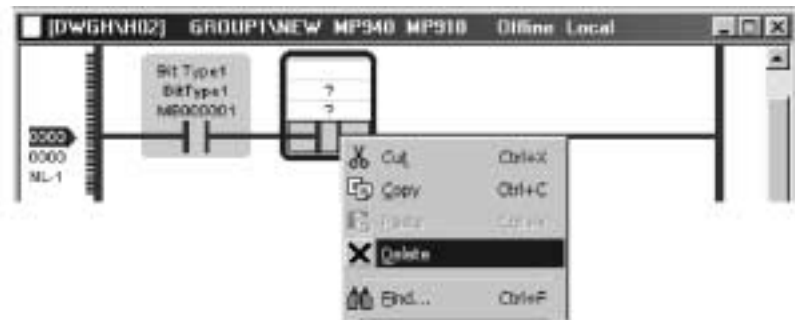

2. The selected instruction is deleted.

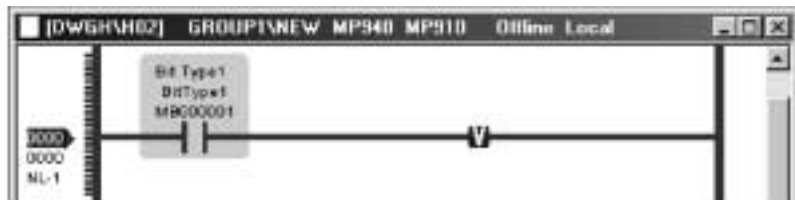

## ■ Cut Instruction

1. Select the cut out instruction and select **Edit (E) - Cut (T)** of the menu or from the pop-up menu by the right-click.



<Key Operation>: Ctrl + X

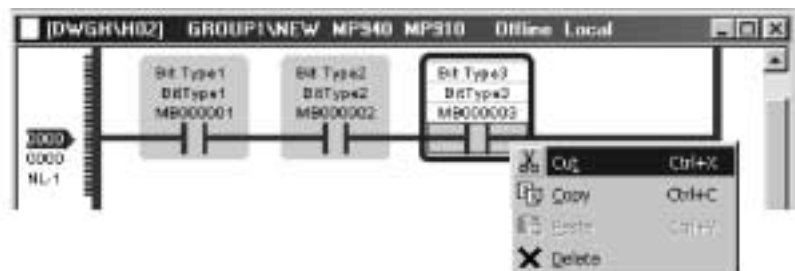



- The selected instruction is cut out and its information is saved in the clipboard.



### ■ Copy Instruction

- Select the cut out instruction and select **Edit (E) - Copy (C)** of the menu or from the pop-up menu by the right-click.



<Key Operation>: Ctrl + C



- The selected instruction is copied and its information is saved in the clipboard.

### ■ Paste Instruction

- Select the pasted position as the guide mark and select **Edit (E) - Paste (P)** of the menu or from the pop-up menu by the right-click.



<Key Operation>: Ctrl + V

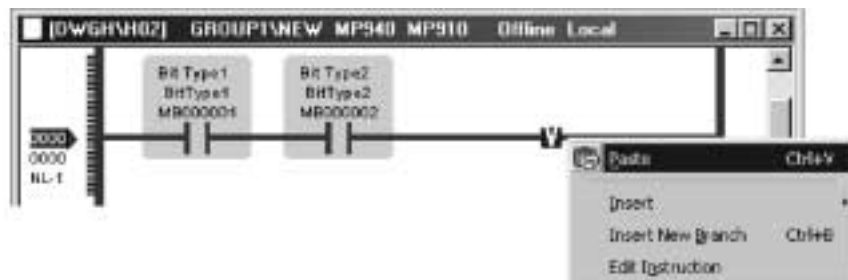

- The instruction saved in the clipboard is pasted on the selected position.

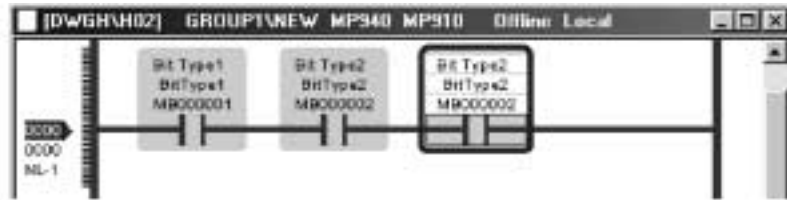

### ■ Move Instruction by Drag & Drop Operation

- Click the instruction name of the instruction to be moved and drag it by holding down the left mouse button. The movement cursor is displayed.

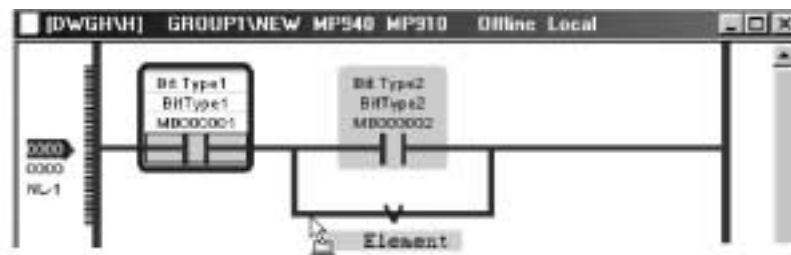

- Release the mouse button at a target position where the guide mark is displayed. The dragged instruction is displayed there.

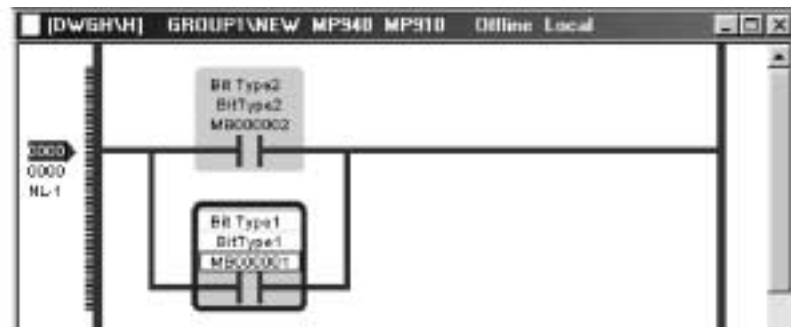

### ■ Copy Instruction by Drag & Drop Operation

1. Click the instruction name of the instruction to be copied and drag it by holding down the left mouse button. The movement cursor is displayed.

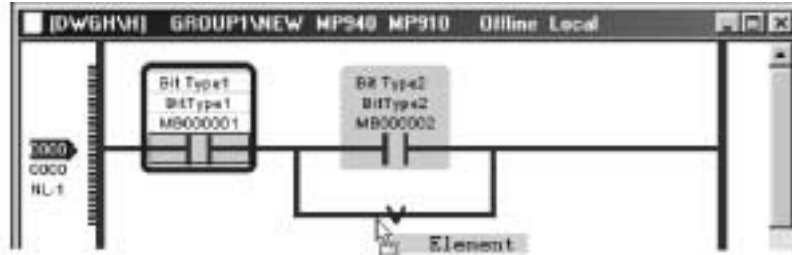

2. Release the mouse button while pushing the Ctrl key at a target position where the guide mark is displayed. The copy mode cursor is displayed.

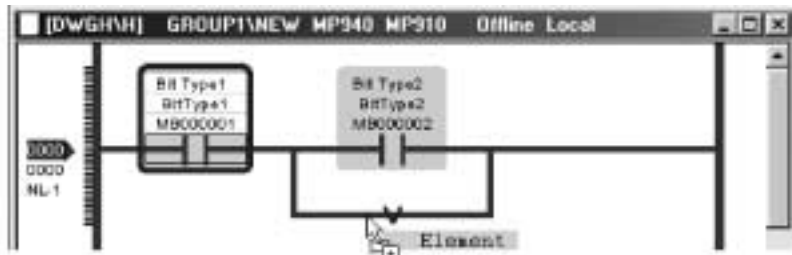

3. The dragged instruction is displayed there.

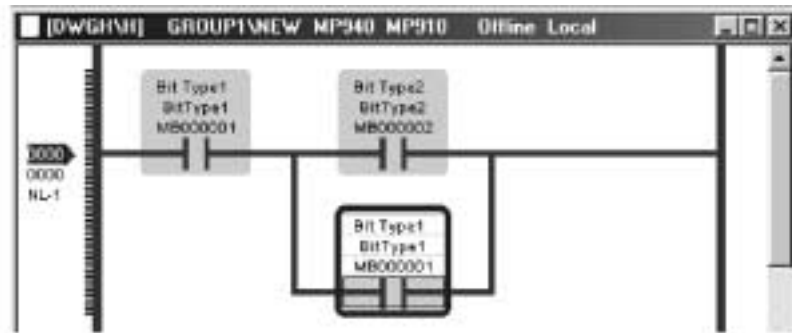

1. The other objects such as branch, branch block, rung, and rung comment can be similarly edited.
2. As for pasting the rung and the rung comment, it is possible only in the area outside the left power rail.

## 2.7.2 Edit Operand of Instruction

### ■ Delete Symbol or Address of Instruction

1. Select the deleted symbol or address of instruction and select **Edit (E) - Delete (D)** of the menu or from the pop-up menu.



<Key Operation>: Delete

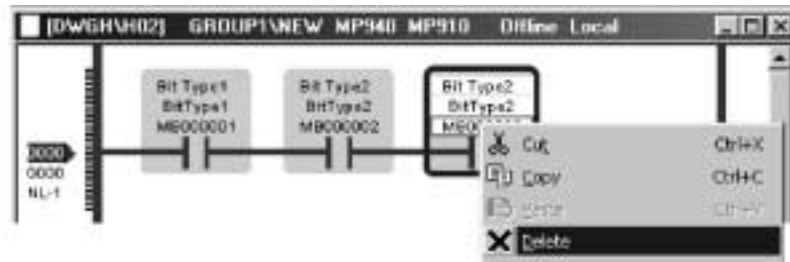

2. The selected symbol or address is deleted.

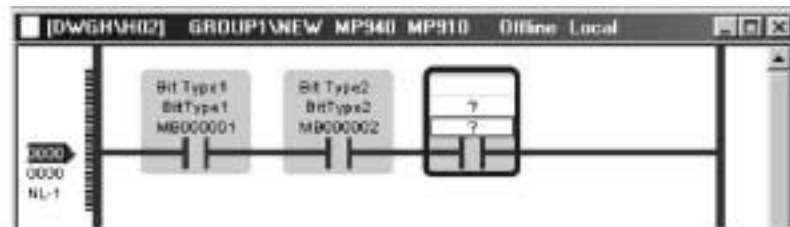

■ Cut/Paste Symbol or Address

1. Select the cut out symbol or address of instruction and select **Edit (E) - Cut (T)** of the menu or from the pop-up menu.



<Key Operation>: Ctrl + X

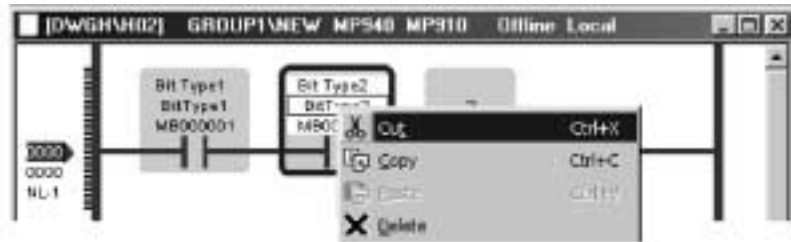

2. Select the pasted position as the guide mark and select **Edit (E) - Paste (P)** of the menu or from the pop-up menu by the right-click.



<Key Operation>: Ctrl + V

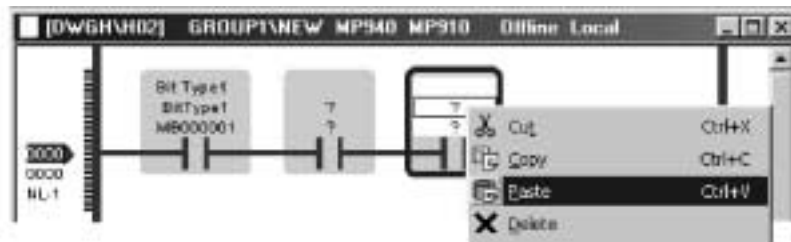

3. The result of Cut/Paste operation is displayed.

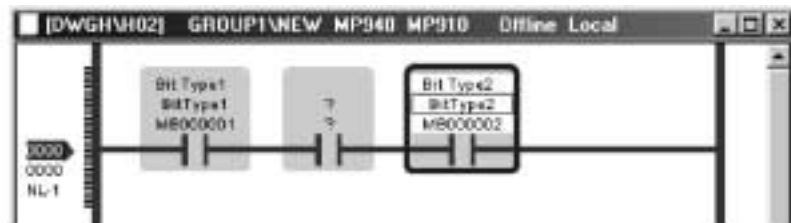

## ■ Copy/Paste Symbol or Address

1. Select the cut out symbol or address of instruction and select **Edit (E) - Copy (C)** of the menu or from the pop-up menu.



<Key Operation>: Ctrl + C



2. Select the pasted position as the guide mark and select **Edit (E) - Paste (P)** of the menu or from the pop-up menu by the right-click.



<Key Operation>: Ctrl + V

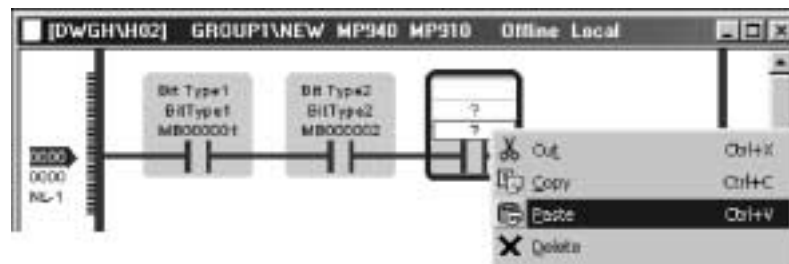

3. The symbol and address of instruction saved in the clipboard is pasted on the selected position.

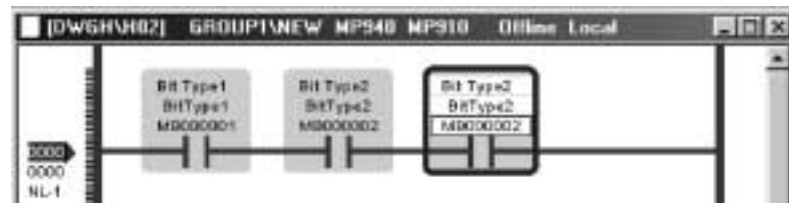

### 2.7.3 Edit Multiple Objects

■ Select Multiple Objects

#### Selecting Objects in a Continuous Range

1. Select the beginning point in the continuous range.

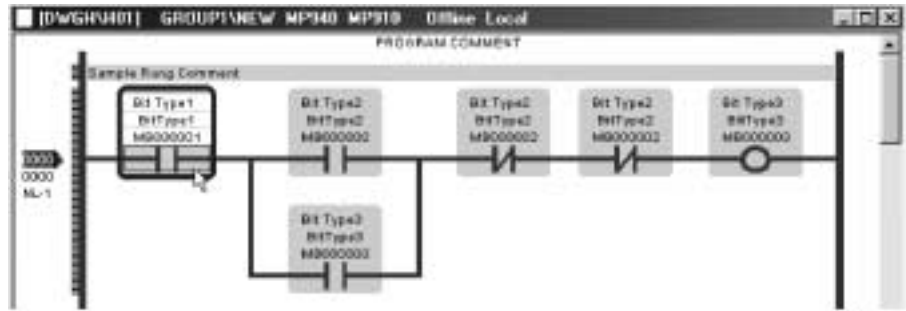

2. Select the end point with the mouse and push the Shift key.

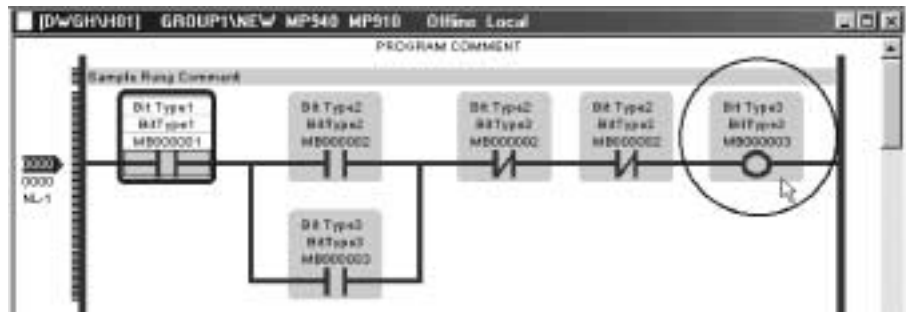

3. All objects are selected between them in continuous range.

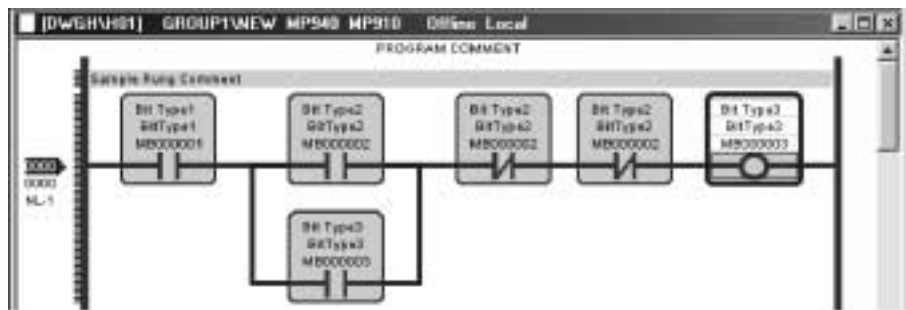

1. <Key Operation>: Shift + Right/Left Arrow Key
2. This operation is available in a whole rung or within the same rung or the same branch.

## Selecting Objects in Non-Continuous Range

1. Select the beginning point in the non-continuous range.

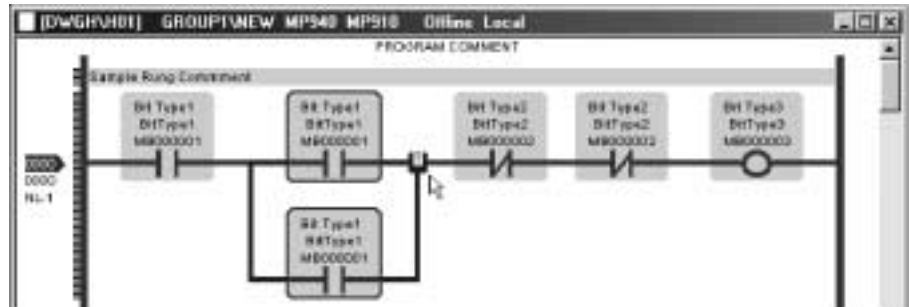

2. Select the ending point with the mouse and press the Ctrl key.



<Key Operation>: move with Ctrl + Arrow Key, select with Ctrl + Enter

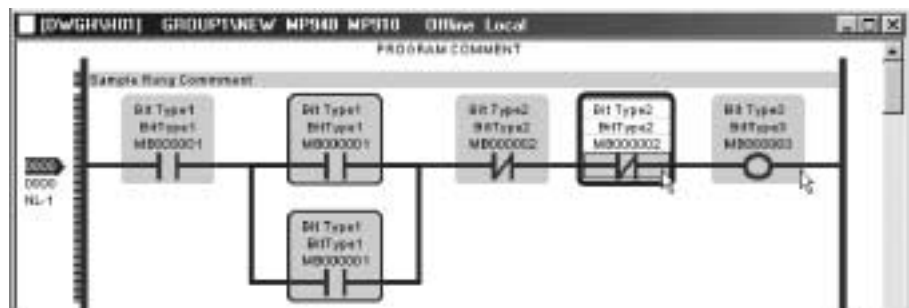

3. All objects are selected between them in non-continuous range.

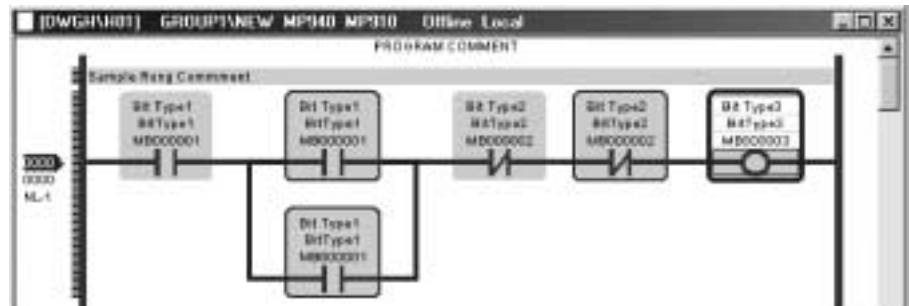



### ■ Cut/Paste Multiple Objects

Multiple objects can be cut out and pasted to the another position.

1. Select the multiple objects and select **Edit (E) - Cut (T)** of the menu or from the pop-up menu by the right-click.



<Key Operation>: Ctrl + X

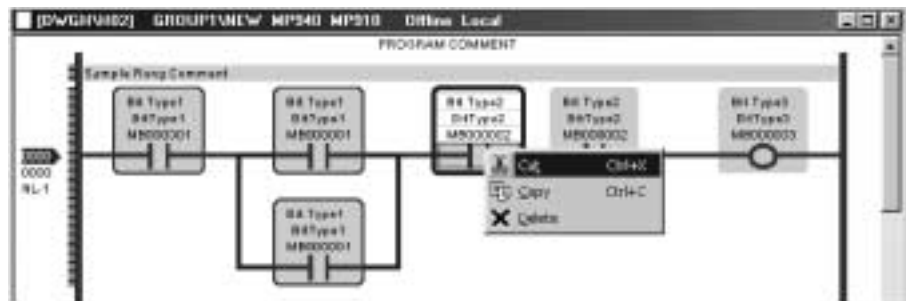

2. The selected multiple objects are cut out and its information is saved in the clipboard.



3. Select the pasted position as the guide mark and select **Edit (E) - Paste (P)** of the menu or from the pop-up menu by the right-click.



<Key Operation>: Ctrl + V



4. The result of Cut / Paste operation is displayed.

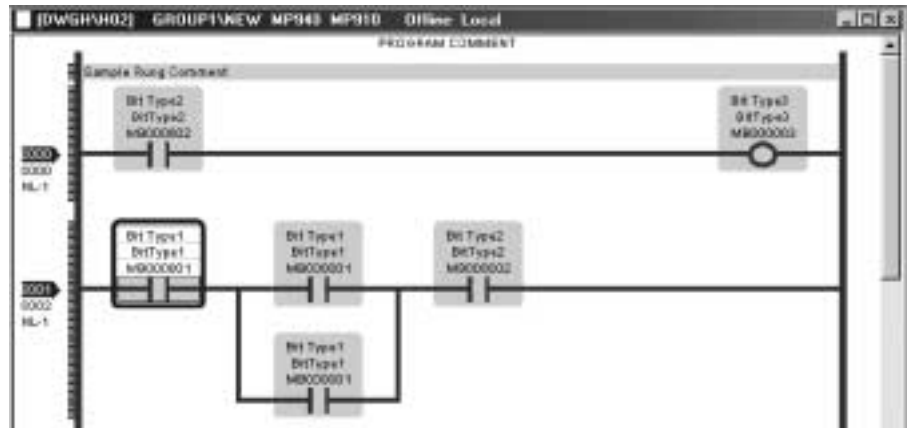

2

### ■ Copy/Paste Multiple Objects

Multiple objects can be copied and pasted to the another position.

1. Select the multiple objects and select **Edit (E) - Copy (C)** of the menu or from the pop-up menu.



<Key Operation>: Ctrl + C

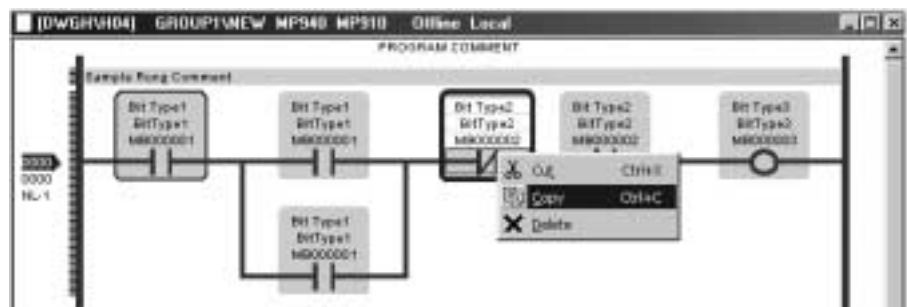

2. The selected multiple objects are copied and saved in the clipboard.
3. Select the pasted position as the guide mark and select *Edit (E) - Paste (P)* of the menu or from the pop-up menu by the right-click.



<Key Operation>: Ctrl + V

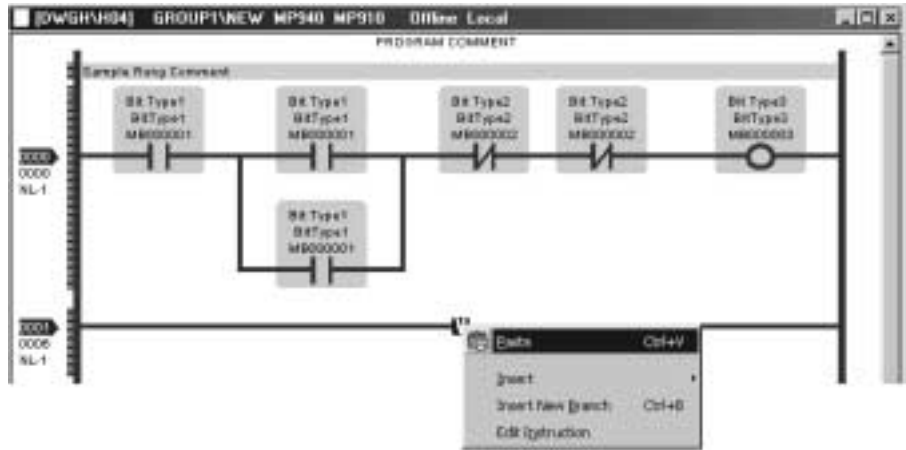

4. The result of Copy/Paste operation is displayed.

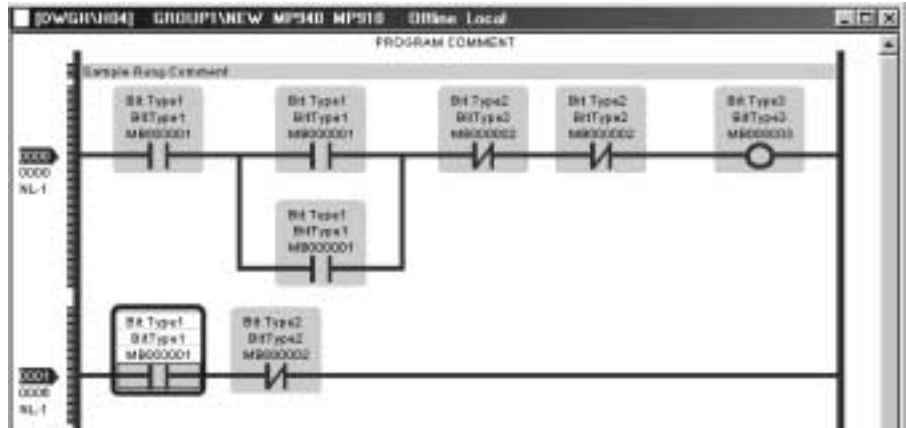

## 2.7.4 Undo

The edit process can be returned by the undo operation. Select **Edit (E) - Undo (U)** of the menu or from the pop-up menu by the right-click.



---

<Key Operation>: Ctrl + Z

---

## 2.7.5 Redo

The edit process can be operated again after undo operation. Select **Edit (E) - Redo (R)** of the menu or from the pop-up menu by the right-click.



---

<Key Operation>: Ctrl + Y

---

## 2.8 SAVE PROGRAM

There are two methods of saving the program, *Save* and *Save All*.

### IMPORTANT

The program is saved in both the hard disk on PC and the controller in on-line mode, but it is saved in only the hard disk on PC in the off-line mode.

### 2.8.1 Save

An active program file is overwrite and saved.

1. Select **File (F) - Save (S)** of the menu.



<Key Operation>: Ctrl + S



2. An active program file is overwrite and saved.

## 2.8.2 Save All

All opened program files are overwrite and saved.

1. Select **File (F) - Save All (L)** of the menu.

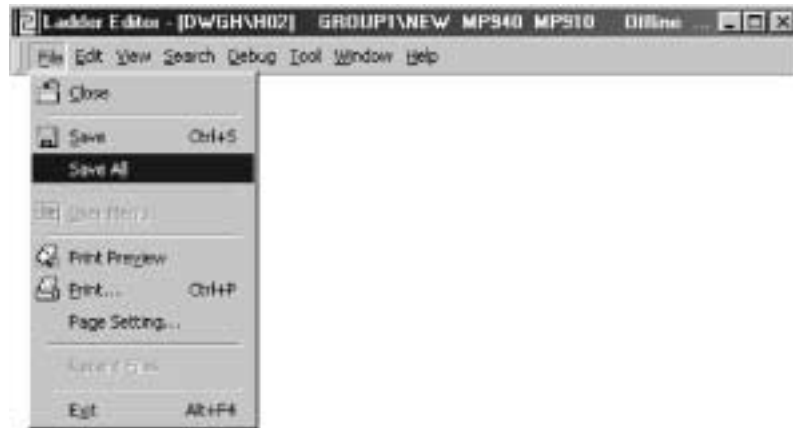

2. All opened program files are overwrite and saved.

## 2.9 VERIFY PROGRAM

The program is compiled.

### IMPORTANT

In the on-line mode, a program is saved to both PLC and a hard disk after verification is completed normally.

In the off-line mode, a program is saved to a hard disk it is not concerned with that verification is normal or error.

### 2.9.1 Verify

An active program file is compiled.

1. Select **Edit (E) - Verify File (V)** of the menu.



<Key Operation>: F8



- An active program file is verified. The result of the compile, warnings, and error messages are displayed in the output window.



- The edit mark in the program disappears when verify is being executed.

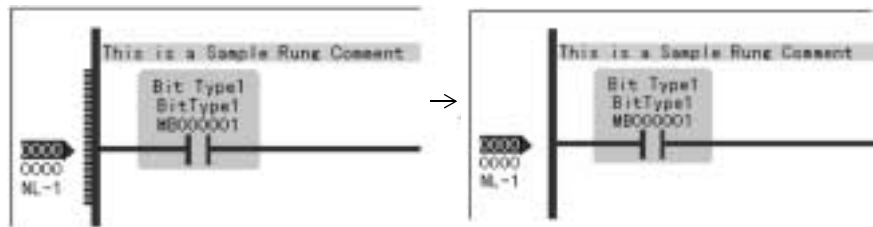

- The display on the tree of the file manager is changed from "Not Compiled File" to "Compiled File" for the file from which verify was executed.

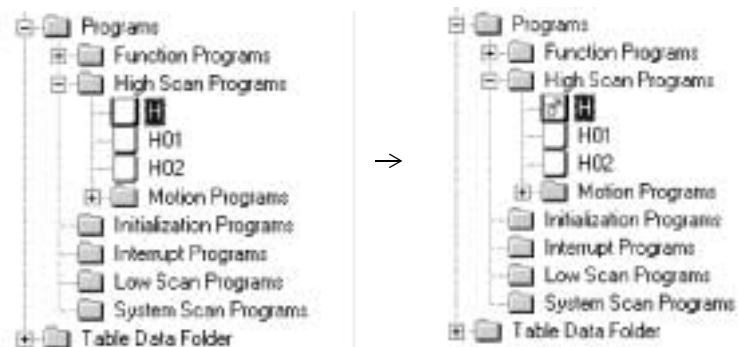

## ■ Error Display Format

### ◀ EXAMPLE ▶

When verify is executed, one example of the content of the display of the output window is shown below.



DWGH\H ( Rung 0, Step 1, Operand 0, Address): error C1041 : The operand is not available.

1            2            3            4            5            6

- Program Name

The program name where error occurs is displayed.



## 2. Rung Number

The rung number where error occurs is displayed.

## 3. Step Number

The step number where error occurs is displayed.

When the instruction does not exist on the rung, 0 is displayed.

## 4. Operand Information

The number and the type such as the symbol and the address, etc. of operand information are displayed.

## 5. Error Code

The code of each error type to the error is displayed.

## 6. Detailed Information

The error detailed content and method of the solution are displayed.

## 2.9.2 Verify All Program

All program files for the selected controller are verified.

1. Select **Edit (E) - Verify All Program Files (F)** of the menu.



- All program files for the selected controller are verified. The result of the compile, warnings, and error messages are displayed in the output window.



- The edit mark in the program disappears when verify is being executed.
- The display on the tree of the file manager is changed from "Not Compiled File" to "Compiled File" for the file from which verify was executed.



***Edit (E) - Verify (F) , Edit (E) - Verify All Program Files (F)*** operation is available from the File Manager window as well as the Ladder Editor window.

---

## DISPLAY

3.1 EDITOR OPTION DIALOG	3-2
3.1.1 Editor Option Dialog Configuration	3-2
3.1.2 Color	3-2
3.1.3 Font	3-5
3.1.4 Ladder Display	3-6
3.1.5 Control	3-9
3.1.6 Key	3-10
3.2 ZOOM	3-11
3.3 INSTRUCTION PALETTE	3-12
3.3.1 Instruction Palette	3-12
3.3.2 User Customized Tab	3-13
3.3.3 Quick View Property	3-16
3.4 OUTPUT WINDOW	3-18
3.4.1 Output Window Display	3-18
3.4.2 Detail of the Output Window	3-19
3.5 TOOLBAR CUSTOMIZE DIALOG	3-20
3.5.1 Display and Configuration of Toolbar Customize Dialog	3-20
3.5.2 Commands	3-20
3.5.3 Toolbars	3-21
3.5.4 Keyboard	3-22
3.5.5 Other	3-23
3.5.6 Edit Icon Image	3-24
3.5.7 Customizing Operation	3-28
3.6 FUNCTION KEYS	3-29
3.6.1 Function Bar	3-29
3.6.2 Function Key Assignment	3-30

## 3.1 EDITOR OPTION DIALOG

### ■ Editor Option Dialog Display

The dialog box where the options of the ladder editor window are displayed.

1. Select **View (V) - Editor Options... (E)**.
2. The editor option dialog is displayed.



<Key Operation>: Alt + Enter

### 3.1.1 Editor Option Dialog Configuration

Tab	Explanation
Color	Set the color of the background, text, and lines in the ladder editor.
Font	Set the font property in the program window.
Ladder	Set the ladder display property in the program window.
Control	Set the max. number of open windows in the output window.
Key	Set the instruction names with a mnemonic key.

### 3.1.2 Color

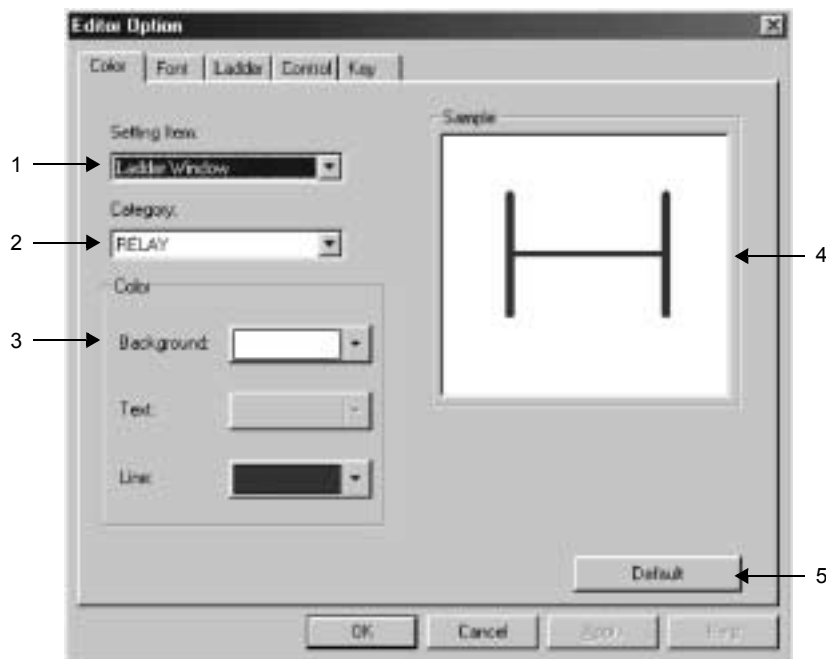

### 1. Setting Item

Select the item from the drop down list displayed with the menu button of the combo box.



### 2. Category

This is available when "instruction" is selected. Click the menu button, and the category of instruction is displayed.



3. Color

The color of the background, text, line is set.

Click the menu button and the color set box is displayed.

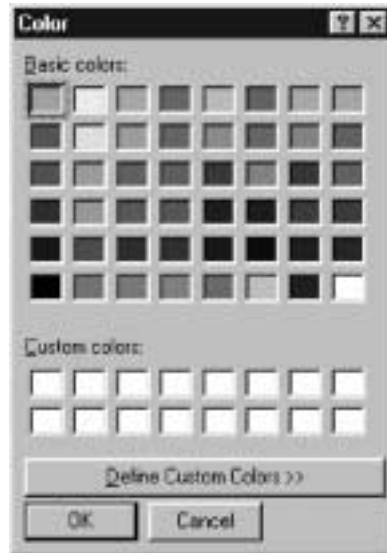

- Background

The background color is set.

- Text

The text color is set.

- Line

The line color is set.

4. Sample

The selections of a set item, the category, and the color, etc. are preview displayed.

5. Default

All settings in the color tab are returned to the default settings.

### 3.1.3 Font

The font displayed in the program window is set.

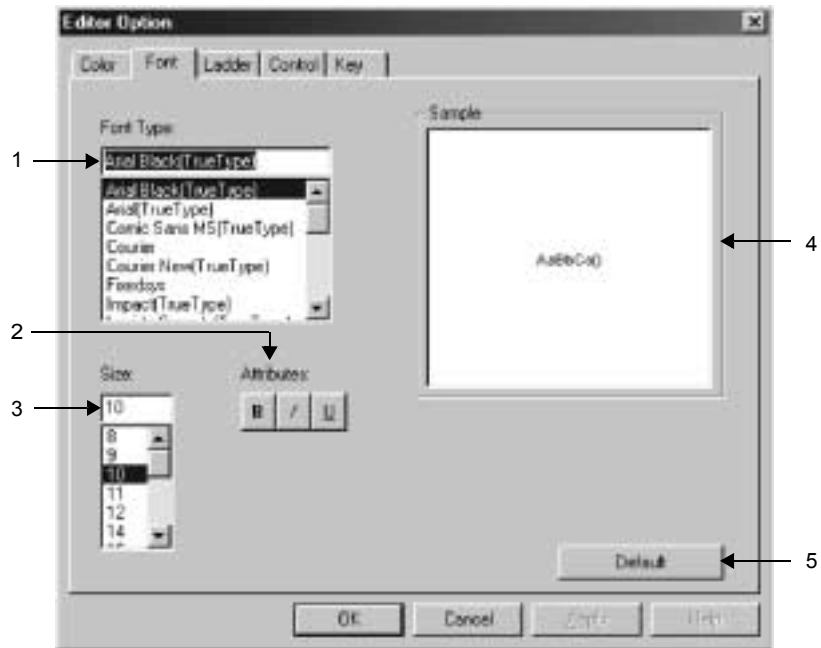

#### 1. Font Type

The selected font in the combo box list is displayed.

#### 2. Attributes

- **B** : The bold-faced type is set or unset.
- **I** : The italic character type is set or unset.
- **U** : The underline of the character is set or unset.

#### 3. Size

The font size is set.

#### 4. Sample

The preview of the selected character is displayed.

#### 5. Default

All settings in the font tab are returned to the default settings.

### 3.1.4 Ladder Display

A detailed display item in the program window is set.

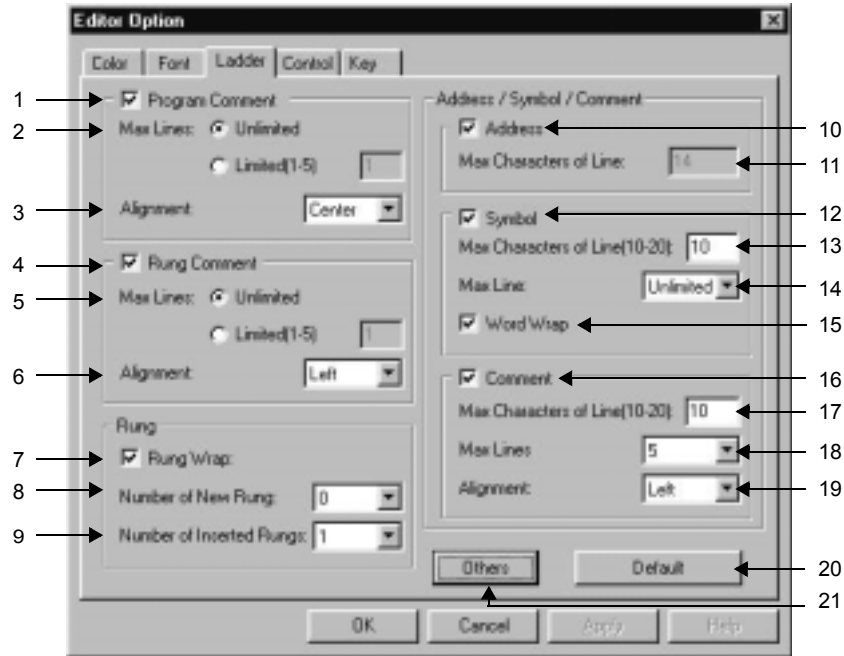

#### Program Comment

##### 1. Program Comment

Display/Hide of the program comment is set by the check box.

##### 2. Max Lines

Unlimited: There is no limitation.

Limited (1-5): There is the limitation of the display number of lines of the program comment.

##### 3. Alignment

The display positions in the program comment are set in either the left justification, the center or the right justification.

#### Rung Comment

##### 4. Rung Comment

Display/Hide of the rung comment is set by the check box.

##### 5. Max Lines

Unlimited: There is no limitation.

Limited (1-5): There is the limitation of the display number of lines of the rung comment.



## 6. Alignment

The display positions in the rung comment are set in either the left justification, the center or the right justification.

## Rung

### 7. Rung Wrap

The rung turn control is available or not available is set by the check box.

### 8. Number of New Rungs

The number of rung when new program is created is set.

### 9. Number of Inserted Rungs

The number of rung when it is inserted is set.

## Address

### 10. Address

Display/Hide of the address of the instruction is set by the check box.

### 11. Max Characters of Line

The maximum of characters a line is fixed by 14 now.

## Symbol

### 12. Symbol

Display/Hide of the symbol of the instruction is set by the check box.

### 13. Max Characters of Line 10-20

The maximum number of characters on a line is set between 10 and 20.

### 14. Max Line

The maximum number of lines is set between 1 and 5 or set to no limit.

### 15. Word Wrap

The character string return function is set or not set by the check box.

## Comment

### 16. Comment

Display/Hide of the comment of the instruction is set by the check box.

### 17. Max Characters of Line

The maximum number of characters on a line is set between 10 and 20.

### 18. Max Line

The maximum number of lines is set between 1 and 5.

### 19. Alignment

The display positions in the comment of the instruction are set in either the left justification, the center or the right justification.

## 20. Default

All settings in the ladder tab are returned to the default settings.

## 21. Others

The Expression and detailed program comment is set.

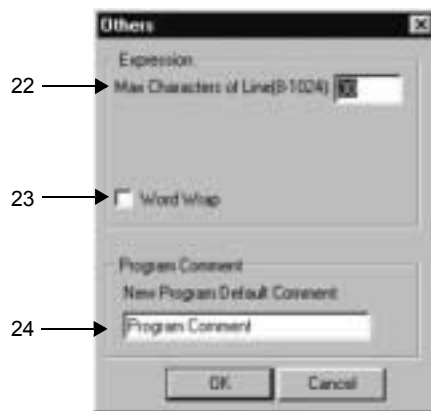

## Expression

### 22. Max Characters of Line (1-512)

The maximum number of characters on a line is set between 1 and 512.

### 23. Word Wrap

The character string return function at more than the maximum number of characters displayed is set or not set by the check box. When not set, the characters over the maximum of characters are not displayed.

## Program Comment

### 24. New Program Default Comment

Character string as program comment is set, when new program is opened. "Program Comment" is displayed as the default.

### 3.1.5 Control

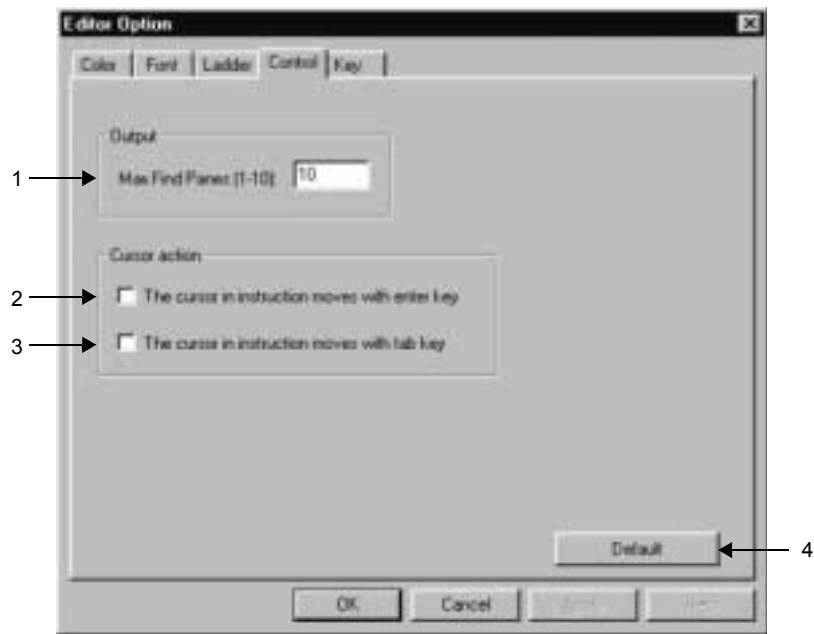

#### Output

##### 1. Find Windows (1-10)

The number of windows displayed in the output window is set. The default number is three.

#### Cursor action

##### 2. Cursor in the Instruction moves with Enter key.

The cursor in the instruction moves with Enter key when the cursor is in the instruction.

##### 3. Cursor in the Instruction moves with Tab key.

The cursor in the instruction moves with Tab key when the cursor is in the instruction.

#### Default button

##### 4. All settings in the control tab are returned to the default settings.

### 3.1.6 Key

The allocation of shortcut commands for each instruction is displayed.

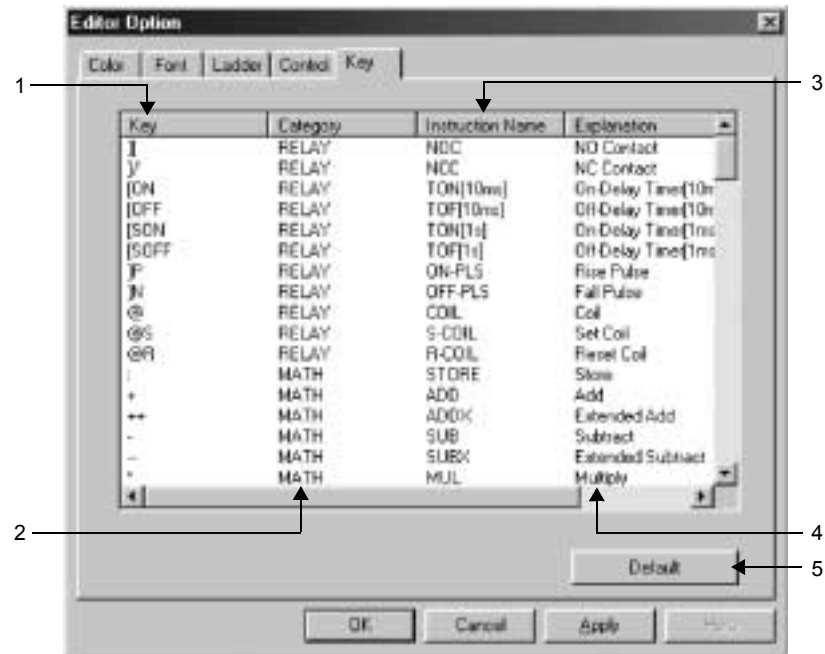

1. Key

Each shortcut command as mnemonic key is displayed.

2. Category

The category of instruction is displayed.

3. Instruction Name

The instruction name is displayed.

4. Explanation

The explanation for instruction is displayed.

5. Default

All settings in the key tab are returned to the default settings.

#### ■ Change the mnemonic key

1. Move the cursor to the key to be changed.
2. Click the key item and it is changed to the edit mode.
3. Change the key and press the Enter key. This change is effective the next time the ladder editor is started.



<Key Operation>: F2

## 3.2 ZOOM

The display scaling of the ladder window is set.

1. Select **View (V) - Zoom (Z)**.
2. The zoom dialog box is displayed.

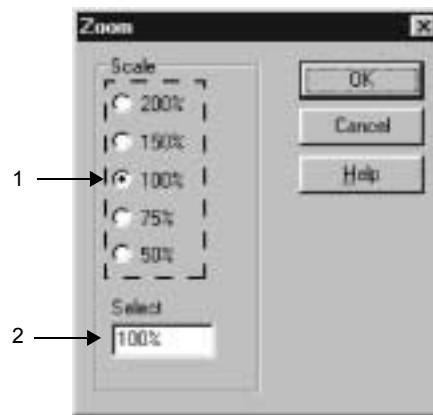

### ■ Zooming

1. Scale  
Select the button for the prepared scale.
2. Select  
Input the specified scale in the input box.

## 3.3 INSTRUCTION PALETTE

The instruction palette displays the instruction group for the ladder programming by dividing each category in the tab. The instruction dragged from the instruction palette is dropped on a target position in the program. The original tabs can be used or added on the instruction palette by the user.

### 3.3.1 Instruction Palette

Display/Hide of the instruction palette can be set with selecting *View (V) - Instruction Palette (I)*.

#### ■ Instruction Palette Display

1. Select *View (V) - Instruction Palette (I)*.
2. The instruction palette is displayed.

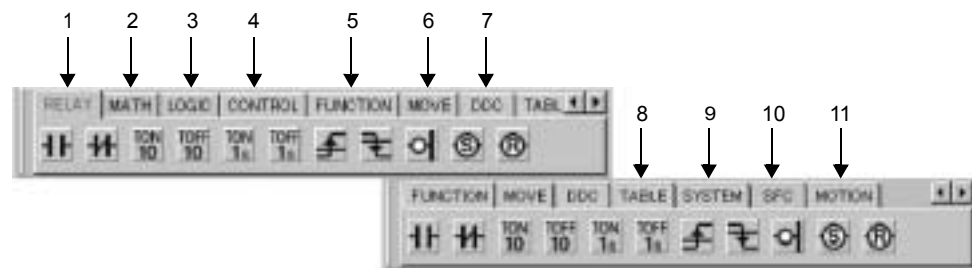

1. RELAY  
The RELAY category is displayed.
2. MATH  
The MATH category is displayed.
3. LOGIC  
The LOGIC category is displayed.
4. CONTROL  
The CONTROL category is displayed.
5. FUNCTION  
The FUNCTION category is displayed.
6. MOVE  
The MOVE category is displayed.
7. DDC  
The DDC category is displayed.
8. TABLE  
The TABLE category is displayed.
9. SYSTEM  
The SYSTEM category is displayed.

## 10. SFC

The SFC category is displayed.

## 11. MOTION

The MOTION category is displayed.

Note: Refer to Appendix A for detailed information.

### 3.3.2 User Customized Tab

The user original tab can be customized on the instruction palette by using instructions on it.

#### ■ User Customized Tab Display

1. Select **Tool (T) - Customize User Tab... (C)**.

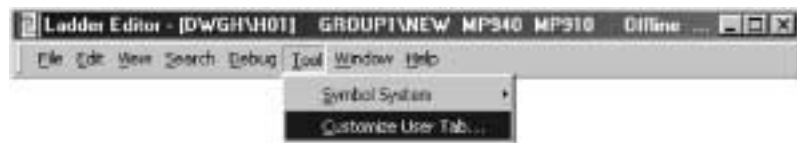

2. The customize user tab is displayed.



#### Details of Customize User Tab Dialog

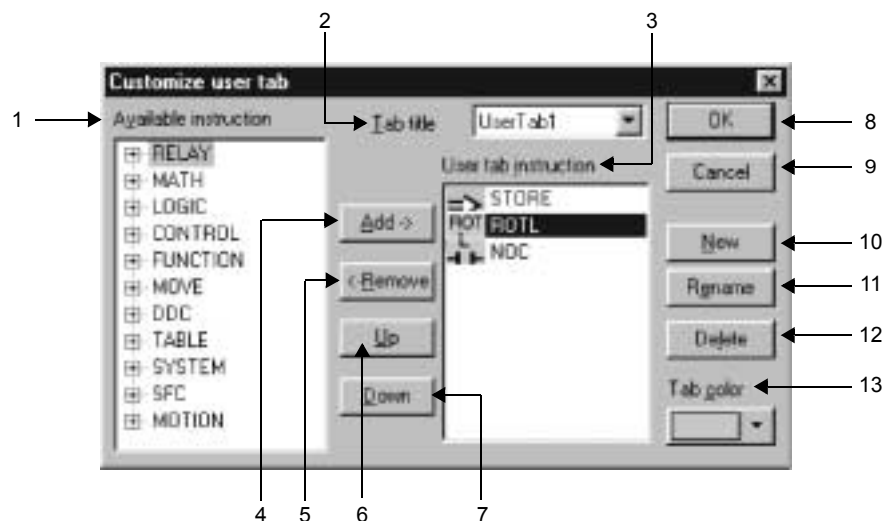

## 1. Available Instruction

All instructions of each category on the instruction palette are displayed.

## 2. Tab Title

The name of the edited user tab is displayed.

## 3. User Tab Instruction

The instruction registered in the user tab to be edited is displayed.

## 4. Add →

The instruction selected from available instruction window is registered in the user tab.

## 5. ← Remove

The specified instruction on the user tab is deleted.

## 6. Up

The cursor in the user tab instruction window moves to the upper direction.

## 7. Down

The cursor in the user tab instruction window moves to the lower direction.

## 8. OK

The Setting is reflected in the instruction palette, and the dialog is closed.

## 9. Cancel

The Setting is canceled, and the dialog is closed.

## 10. New

The user tab is newly created.

## 11. Rename

The edited user tab is renamed.

## 12. Delete

The edited user tab is deleted.

## 13. Tab Color

The background color for the edited user tab is set.



## ■ Set Customized User Tab

1. Select the New button.

Input the user tab name in the dialog.



2. Select the added instruction in the available instruction window.

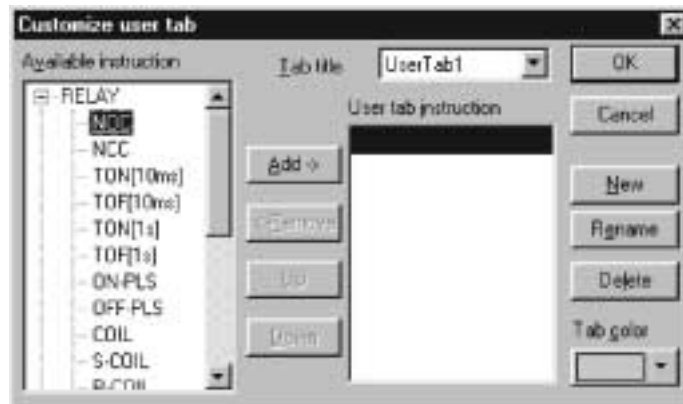

3. Select the Add button and the selected instruction is registered in the user tab instruction window.



4. Set the tab color and select the OK button, the specified user tab is added on the instruction palette.



### 3.3.3 Quick View Property

The quick view property sets the display form of the operand of the instruction. Display/Hide of the quick view property can be set with selecting *View (V) - Quick View Property (V)*.

#### ■ Quick View Property Display

1. Select *View (V) - Quick View Property (V)*.
2. The quick view property is displayed.

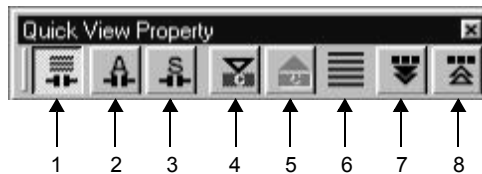

1. Symbol/Comment/Address Display

The address, symbol, and comment of the instruction are all displayed.



2. Address/Comment Display

The address and comment of the instruction are displayed.



3. Symbol/Comment Display

The symbol and comment of the instruction are displayed.



## 4. Decrease the Number of Comment Lines

The number of comment lines displayed is decreased by one line at each click.

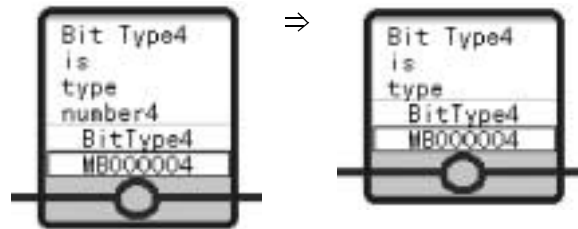

## 5. Increase the Number of Comment Lines

The number of comment lines displayed is increased by one line at each click.

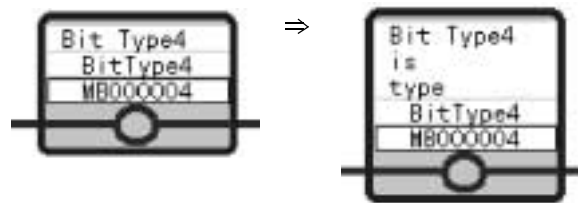

## 6. Number of Comment Lines Display

The present number of comment lines is displayed.

## 7. Scope All On

The scope of all the instructions is turned on.

## 8. Scope All Off

The scope of all the instructions is turned off.

## 3.4 OUTPUT WINDOW

The output window is a window that shows the execution result of Find/Replace/Verify operation under the program window. The Display/Hide can be set with selecting **View (V) - Output (O)** of the menu.

### 3.4.1 Output Window Display

1. Select **View (V) - Output (O)**.

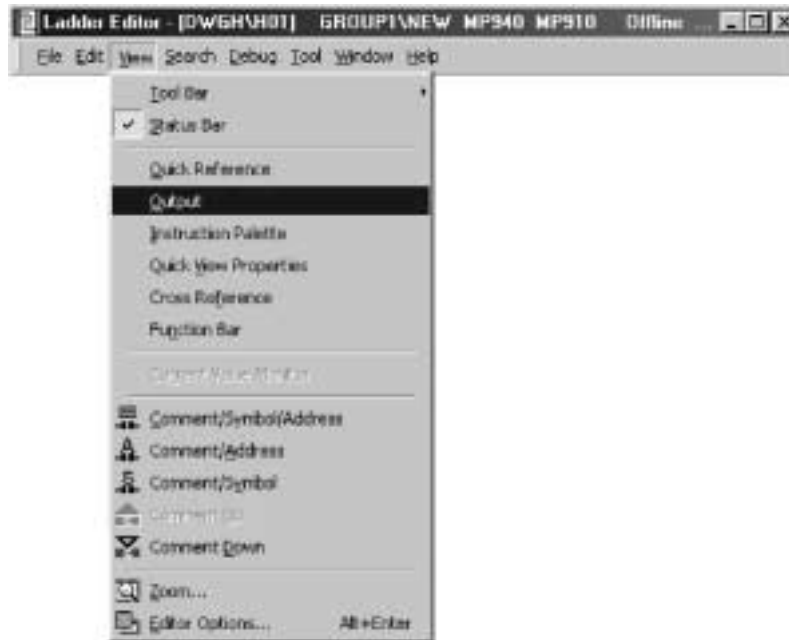

2. The output window is displayed under the program window.

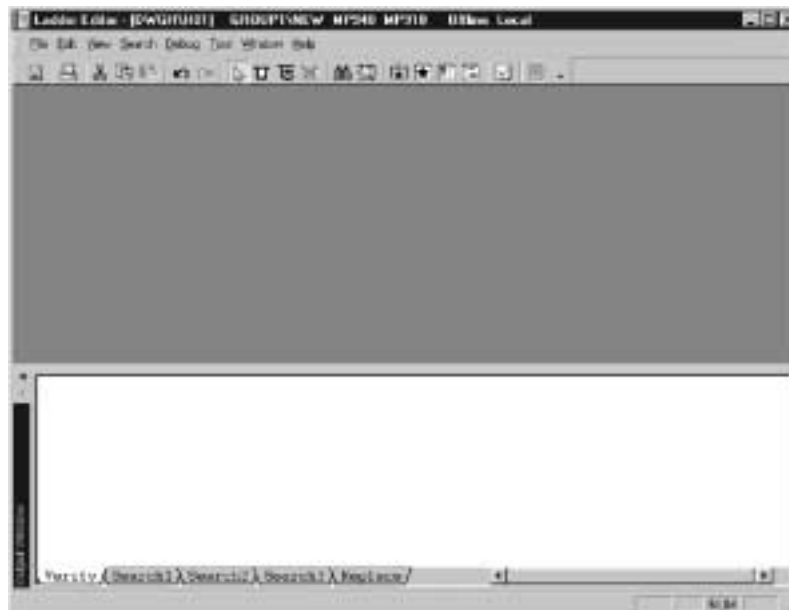

### 3.4.2 Detail of the Output Window

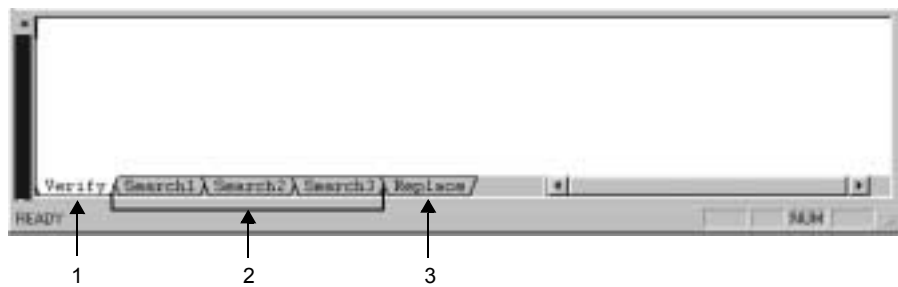

1. Verify

The result of the verify execution, the warnings, the error messages are displayed in the output window.

2. Find

The result of "Find All" operation is displayed. The number of windows that is changeable in the editor option dialog is set as the default.

3. Replace (supported in the future)

The result of "Replace All" operation is displayed.

## 3.5 TOOLBAR CUSTOMIZE DIALOG

### 3.5.1 Display and Configuration of Toolbar Customize Dialog

#### ■ Toolbar Customize Dialog Box Display

The dialog box where the customized data of the toolbar is set is displayed.

1. Select **View (V) - Toolbar (T) - Customize (C)** of the menu or right-click on the toolbar and select **Customize (C)**.
2. The toolbar customize dialog box is displayed.

#### ■ Toolbar Customize Dialog Configuration

Tab	Content
Commands	Display the list of commands added to the toolbar.
Toolbars	Create a new customized toolbar and rename it.
Keyboard	Set the shortcut key for each command.
Others	Set the properties of the menu and the toolbar.

### 3.5.2 Commands

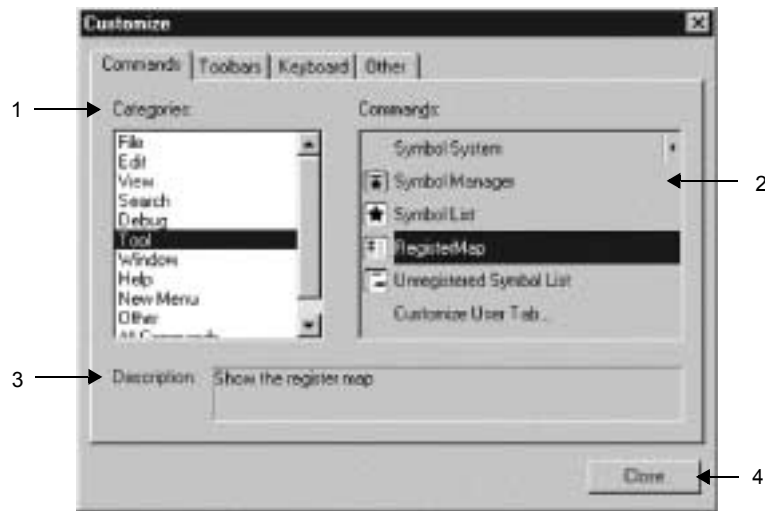

1. Categories  
Select the category of the command added to the toolbar.
2. Commands  
The command list of the selected category is displayed.
3. Description  
The description of the selected command is displayed.
4. Close  
The toolbar customize dialog box is closed.

### 3.5.3 Toolbars



1. Toolbars

Set the check box of the toolbar.

2. Reset

Reset the selected standard toolbar. All customized data is removed from it. The button is disabled when the user-defined toolbar is selected.

3. Reset All

Reset all standard toolbars except the user-defined toolbars.

4. New

Create a new user-defined toolbar. The toolbar name dialog box is displayed when the button is selected. Input the toolbar name in the input box.



5. Rename

Rename the user-defined toolbar.

6. Delete

Delete the user-defined toolbar.

## 7. Show text labels

Set the display/hide the button labels on the toolbar.



## 3.5.4 Keyboard

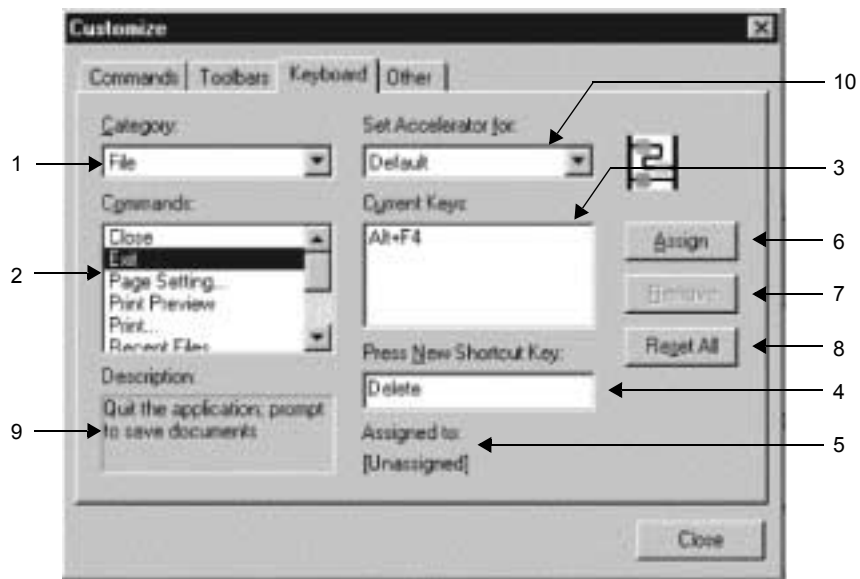

## 1. Category

Select the category from the drop down list.

## 2. Commands

Select the command assigned to the shortcut key.

## 3. Current Keys

The current assigned shortcut key of the selected command is displayed.

## 4. Press New Shortcut Key

Input the shortcut key assigned to the selected command in the input box. It is automatically displayed as "Ctrl + C" when Ctrl + C is input.

## 5. Assigned to:

The current command assigned by the shortcut key input in the input box above is displayed. It is displayed, "Unassigned" when not assigned.

## 6. Assign

Assign the new shortcut key in the input box to the selected command.



## 7. Remove

Remove the assignment of the shortcut key from the selected command.

## 8. Reset All

Reset all assignments of the shortcut keys. The assignments of the shortcut keys returns to the initial settings.

## 9. Description

The function description of the selected command is displayed.

## 10. Set Shortcut for:

Supported in the future.

## 3.5.5 Other

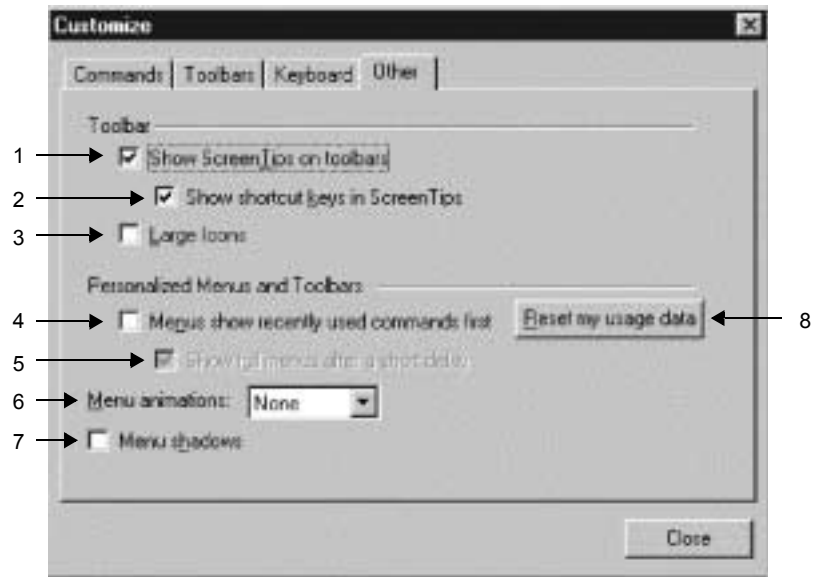

## Toolbar

## 1. Screen tip

Set display/hide of the screen tip on the toolbar.

## 2. Display of shortcut key in the screen tip

Set display/hide of the shortcut key in the screen tip. This check box is available when screen tip is set to display.

## 3. Icon type

Set large type for the icons on the toolbar.

## Menu

4. Menu display type  
Set the check box, recently used commands are first displayed in the menu.
5. Full menu display  
Set the check box, all the commands are displayed after a few minutes are passed when the cursor is put on the open menu. This check box is available when menu display type is set.
6. Menu animations  
Select the menu animation type to be None, Unfold, Slide, and Fade.
7. Menu shadows.  
Set display/hide of the shadow of the menu.
8. Reset my usage data  
Reset the menu display type changed by recent usage.

## 3.5.6 Edit Icon Image

1. Select **View (V) - Toolbar (T) - Customize (C)** of the menu or right-click on the toolbar and select **Customize (C)**.
2. The toolbar customize dialog box is displayed.
3. Right-click on the selected icon on the toolbar.
4. The pop-up menu is displayed.



### ■ Edit Operation

1. Reset to Default  
Reset the button image and display form of the selected command.
2. Copy button image  
Copy the button image of the selected command. It can be edited in the edit button image dialog.
3. Delete  
Delete the selected command on the toolbar.

## 4. Button Appearance

Modify the design of the selected button. The button appearance dialog is displayed.

## 5. Image

The image of the selected command is displayed.

## 6. Text

The text of the selected command is displayed.

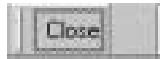

## 7. Image and Text

The image and text of the selected command are displayed.



## 8. Start Group

Insert the separator at the left of the selected command.

## ■ Button Appearance Dialog

The button image assigned to the button is created and modified.

1. Select **View (V) - Toolbar (T) - Customize (C)** of the menu or right-click on the toolbar and select **Customize (C)**.
2. The toolbar customize dialog box is displayed.
3. Right-click on the selected icon on the toolbar.
4. The pop-up menu is displayed.
5. Select Button Appearance of the pop-up menu.
6. The button appearance dialog box is displayed.

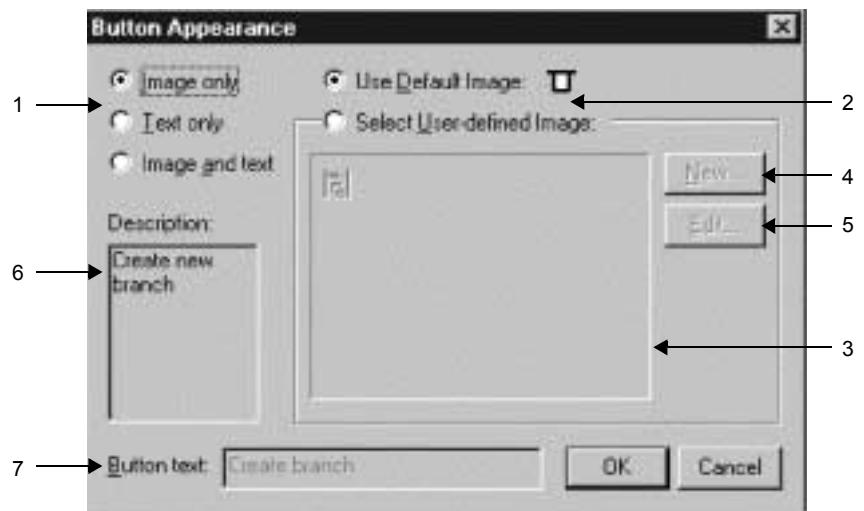

1. Button display form  
Select the display form of the button.
2. Select button image  
Select the used button image.
3. User-defined image list  
The user-defined images are displayed. It is available when the user-defined image is selected.
4. New  
Create a new button image of the command. The edit button image dialog is displayed. It is available when the user-defined image is selected.
5. Edit  
Edit the selected button image of the command. The edit button image dialog is displayed. It is available when the user-defined image is selected.
6. Description  
The function description of the selected command on the toolbar is displayed.
7. Button text  
Modify the caption of the selected button. It is available when 'text only' or 'image and text' is selected in the button display form.

#### ■ Edit Button Image Dialog

The button image assigned to the button is edited.

1. Select **View (V) - Toolbar (T) - Customize (C)** of the menu or right-click on the toolbar and select **Customize (C)**.
2. The toolbar customize dialog box is displayed.
3. Right-click on the selected icon on the toolbar.
4. The pop-up menu is displayed.
5. Select **Button Appearance** of the pop-up menu.
6. The button appearance dialog box is displayed.
7. Select **New (N)** or **Edit (E)** button.

8. The edit button image dialog box is displayed.

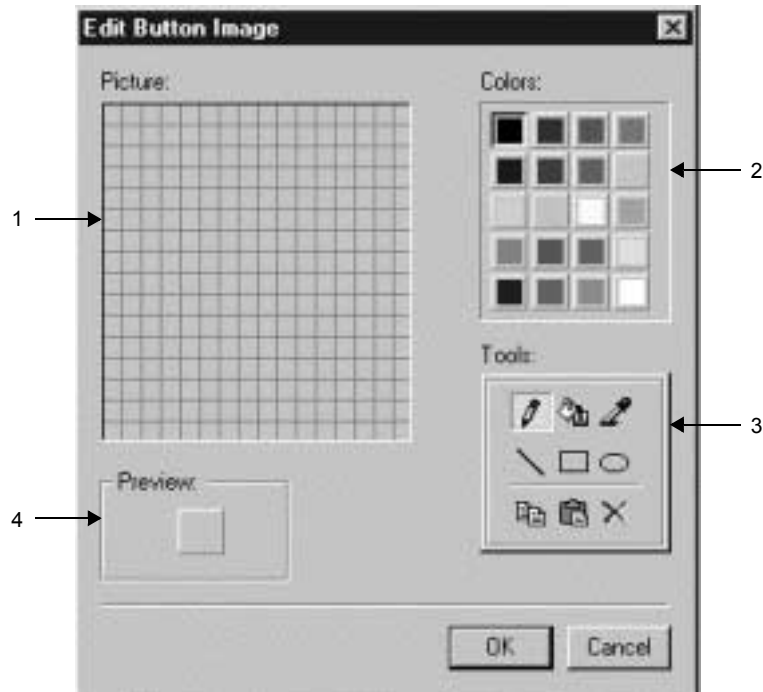

1. Picture

Set or modify the button image by clicking the pixels of the picture.

2. Colors

Select the color of the button image.

3. Tools

Draw the picture using the tools.

4. Preview

The button image is previewed in actual size.

## 3.5.7 Customizing Operation

### ■ Add Command

The customize dialog box is displayed.

1. Select the command tab.
2. Drag the selected icon.
3. Drop it to the selected toolbar.

### ■ Delete Command

The customize dialog box is displayed.

1. Drag the selected icon.
2. Drop it outside the toolbar

## 3.6 FUNCTION KEYS

### 3.6.1 Function Bar

The function bar is displayed.

1. Select **View (V) - Function Bar (U)** from the menu.
2. The function bar is displayed.

The function keys are assigned below.

Function key	Function name	Content
F2	Edit	Put the selected object in editing.
F3	Show Key Assign	The key assignment in the edit option dialog is displayed. It can be edited.
F8	Verify	Verify the program.

The following function keys are only displayed when using the symbol list in the ladder editor. The following function keys are only available when the symbol list is opened. Refer to "5.5 OPERATION IN LADDER EDITOR" for details.

Function key	Function name	Content
F5	Find Next	Search for the next data.
F9	Sort	Sort the selected item.
F11	Program	Activate the program window.
F12	Symbol List	Activate the symbol list. Open the symbol list when it is not opened. It can be edited.

## 3.6.2 Function Key Assignment

The function key assignment is displayed below including the Windows® standard assignment.

It can be changed at the toolbar customize dialog.

Function key	Key operation			
	F key only	Shift + F key	Ctrl + F key	Alt + F key
F1	Help	Screen Tip		
F2	Edit			
F3	Show Key Assign			
F4			Close	End
F5	Find Next			
F6			Next	
F7			Switch Focus	
F8	Verify			
F9	Sort			
F10		Pop-up Menu		
F11	Program			
F12	Symbol List			



The application like the front end processor occasionally uses the function key. Be careful not to compete with that application, in changing the assignment of the function key.



---

## FIND/REPLACE

4.1 FIND	4-2
4.1.1 Find	4-2
4.1.2 Find from Files	4-6
4.2 REPLACE	4-10
4.3 CROSS REFERENCE	4-14
4.3.1 Display Cross Reference Window	4-14
4.3.2 Cross Reference Condition	4-16
4.3.3 Output to File	4-18

## 4.1 FIND

The specified character string is found in the ladder program and its location is displayed.

### 4.1.1 Find

The specified character string is found in the displayed ladder program.

1. Select **Search (S) - Find (F)** of the menu or from the pop-up menu.



<Key Operation > : Ctrl + F

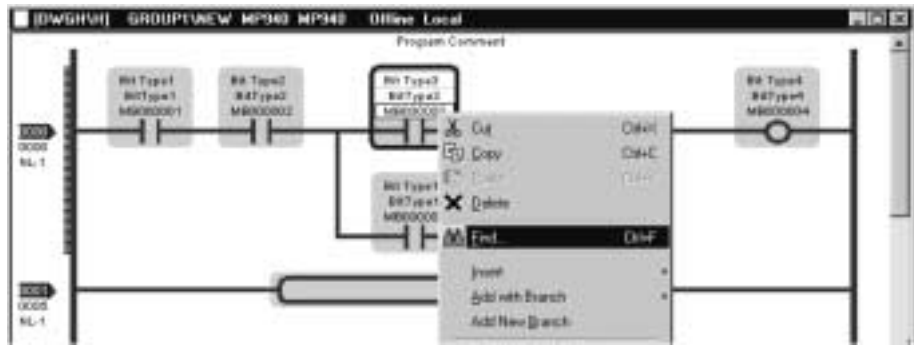

2. The dialog box is displayed.  
Input the found character string and the condition

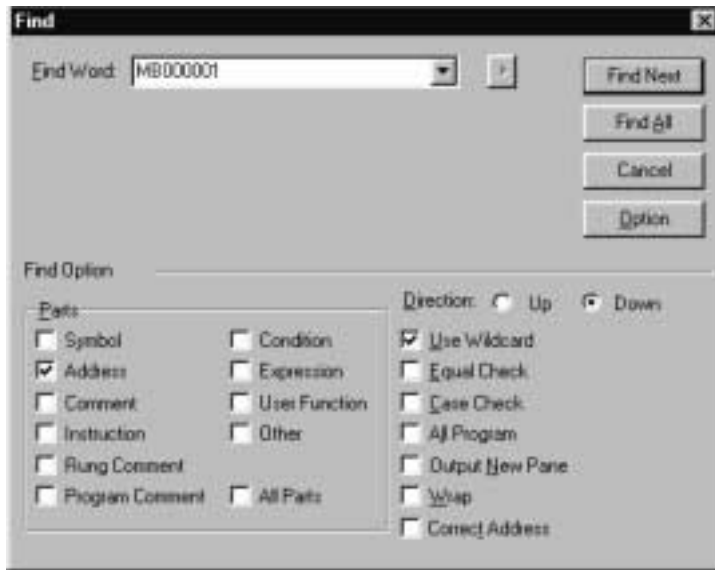

3. Select the Find Next button and a specified character string is found according the specified condition. The cursor is moved to its position and it is displayed in the reverse mode when there is a character string that meets it.

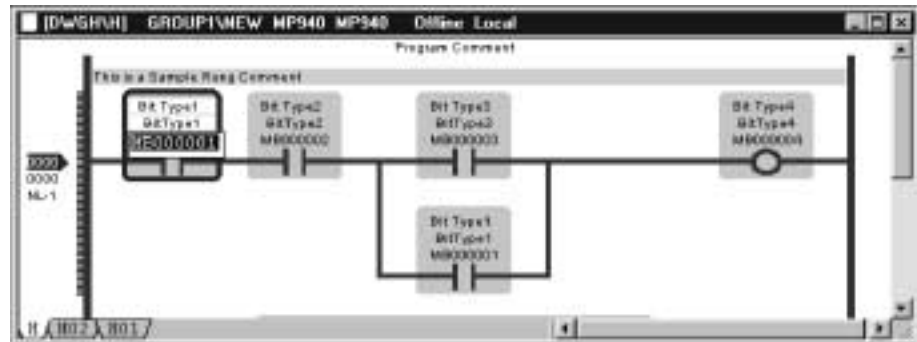

All specified character strings are found according the specified condition when the Find All button is selected. The result of searching is displayed in the output window.

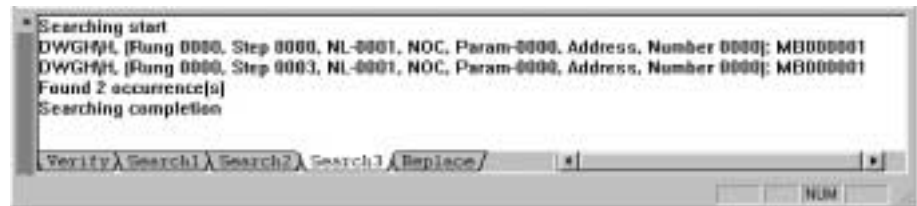

3 panes for finding displayed in the output window are prepared as a default. The default number is changeable in the editor option window. The result of searching is usually displayed in the Search 1 pane and it is displayed in another pane when [Output New Pane] is checked

4. Double-click the result of searching in the pane, the cursor is moved to the specified position in the program and is displayed in the reverse mode.

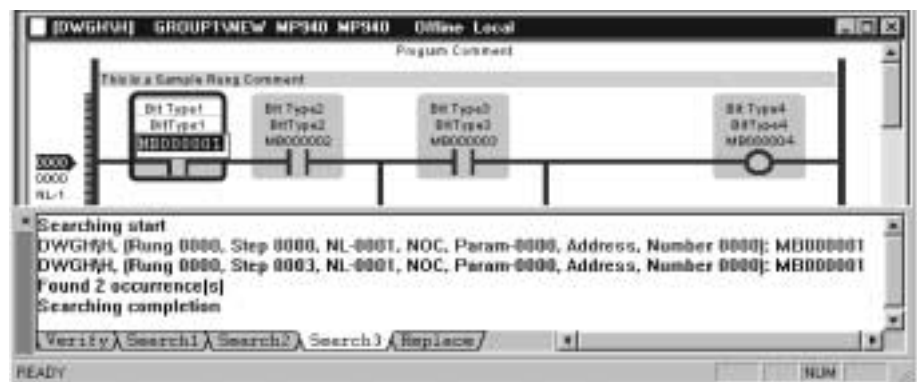

■ Details of Find Dialog

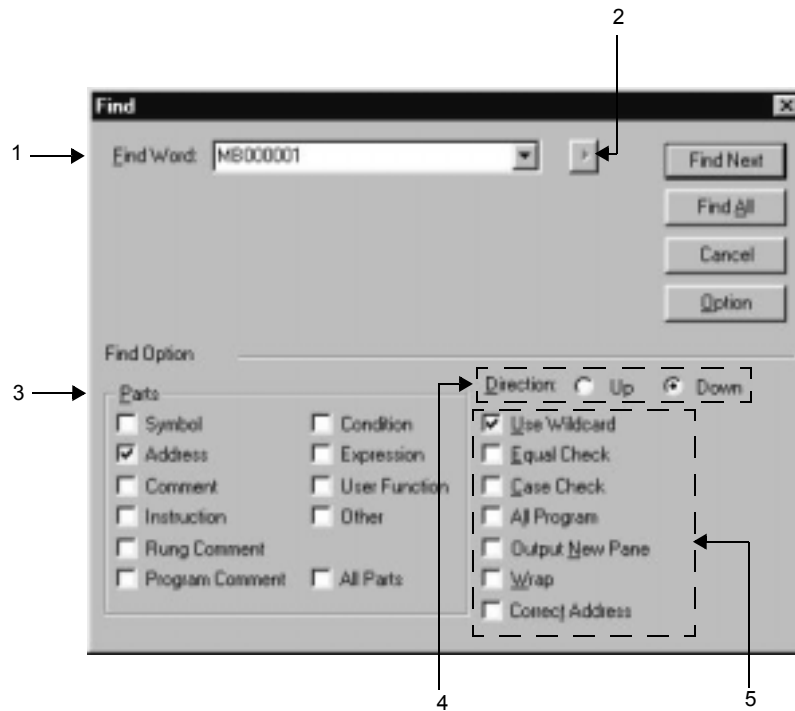

1. Find Word

Input the found character string. The used character strings are displayed in the drop down list and can be used when inputting it.

2. Select Word Dialog Display

This is available when Command is selected.

Select the button and the Select Word dialog box is displayed. The specified instruction is set to the Command input box when clicking the instruction name in it.

The same word is reflected to the Find Word input box in Find dialog box when OK button is selected.

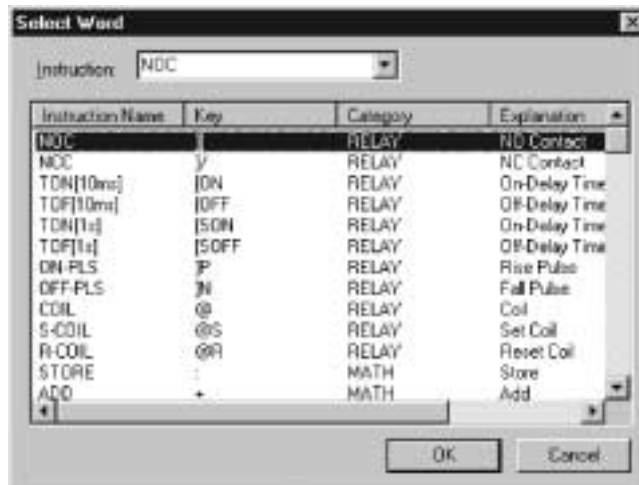

### 3. Parts

The sort of the found character string is set.

### 4. Direction

The direction of searching is set.

### 5. Other Conditions

The other condition is set.

- Use Wildcard

Wild-card (\*,?) is made effective.

- Equal Check

The character string to which the whole is corresponding is found.

- Case Check

The capital letter and the small letter of the input character string are distinguished.

- All Program

All programs opened now are searched.

- Output New Pane

When the Find All button is selected, the result of searching is displayed in the output window as a new pane.

- Wrap

The cursor position wraps entire file when the Find Next button is pushed and the searching is ended.

- Correct Address

When the Address check box of Parts turns on, The register address input is corrected to regular shape. For instance, MW1 is corrected to MW00001.

## 4.1.2 Find from Files

The character string is found specifying the program file.

1. Select **Search (S) - Find from File (I)** of the menu.

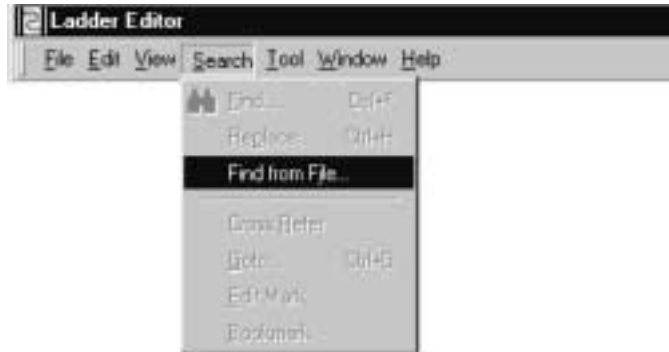

2. The dialog box is displayed.  
Input the found character string and the condition.



3. All specified character strings are found according the specified condition when the Find All button is selected. The result of searching is displayed in the output window.

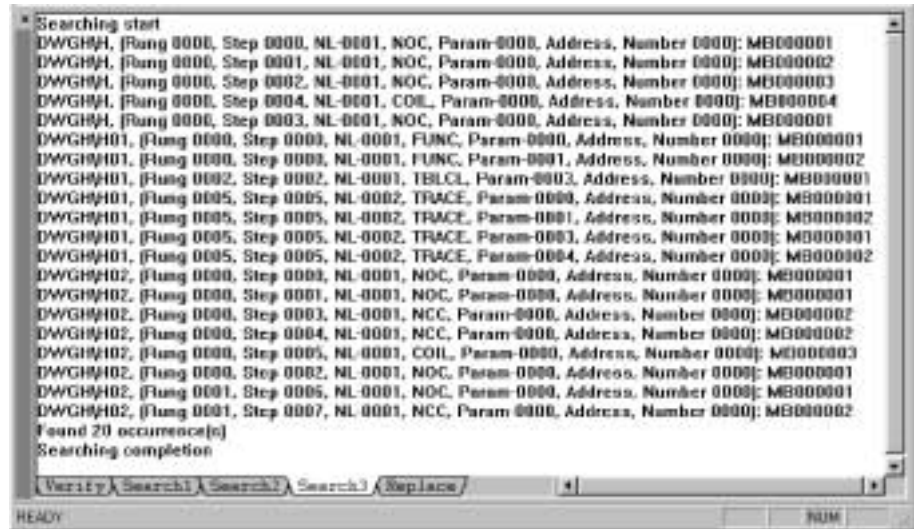

4. Double-click the result of searching in the pane, the cursor is moved to the specified position in the program and is displayed in the reverse mode.

4



<Key Operation> : Enter

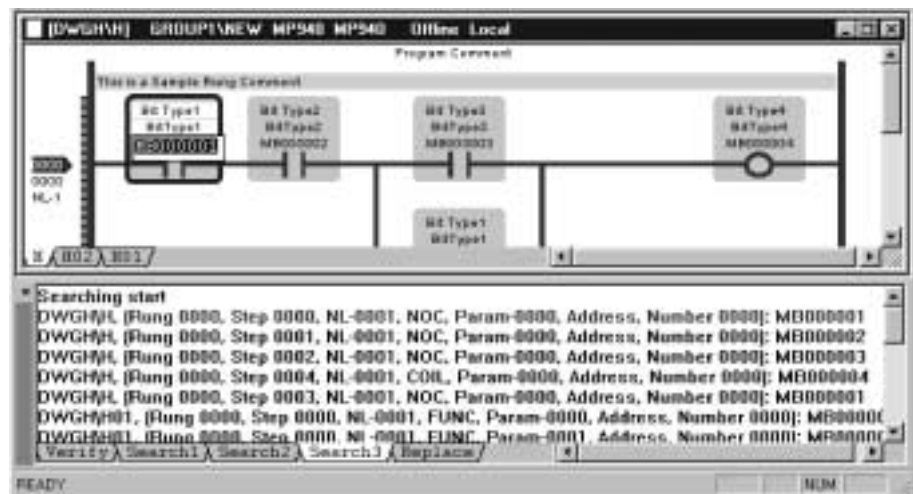

■ Details of Find for File Dialog

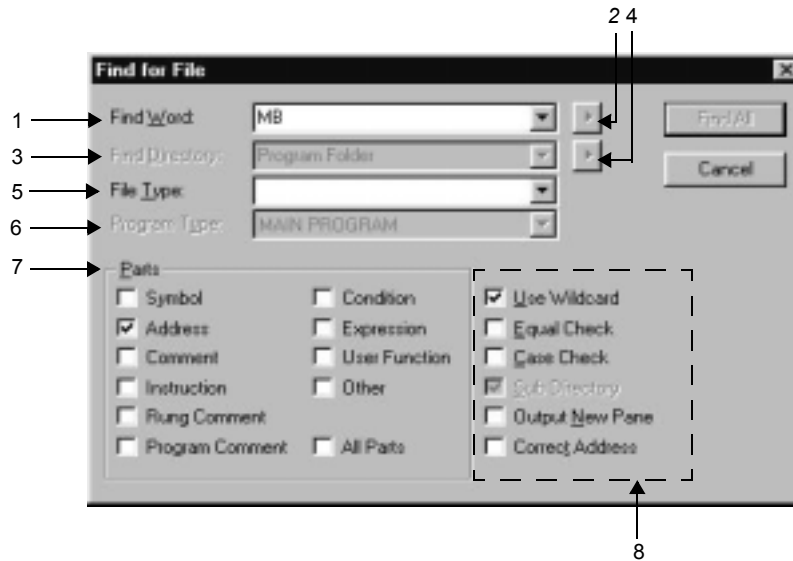

1. Find Word

Input the found character string. The used character strings are displayed in the drop down list and can be used when inputting it.

2. Select Word Dialog Display

This is available when Command is selected.

Select the button and the Select Word dialog box is displayed. The specified instruction is set to the Command input box when clicking the instruction name in it.

The same word is reflected to the Find Word input box in Find dialog box when OK button is selected.

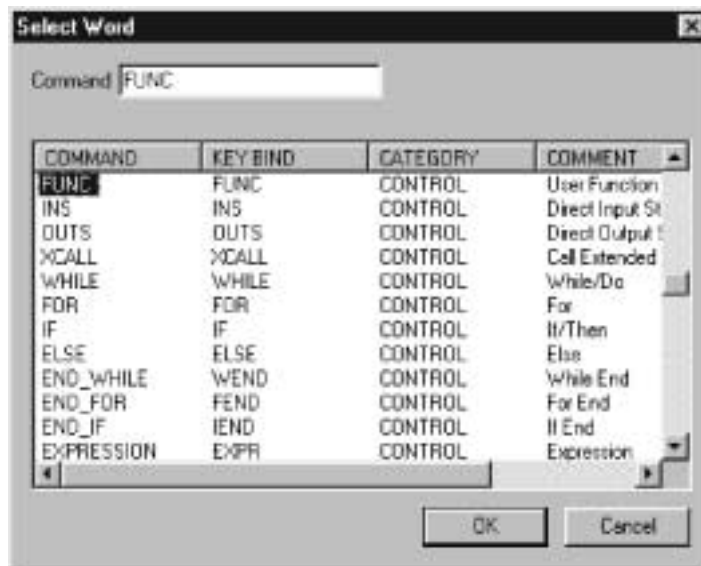



3. File Directory (supported in the future)

Input the found folder. The used folder names are displayed in the drop down list and can be used when inputting it.

4. Select Folder Dialog Display (supported in the future)

Select the button and the Select Folder dialog box is displayed. The specified folder is set to the Folder input box when clicking the folder in it.

The same folder is reflected to the Find Directory input box in Find for File dialog box when OK button is selected.

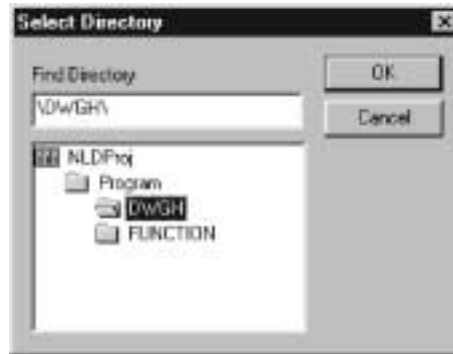

5. File Type

The found file name is set. The used file name are displayed in the drop down list and can be used when inputting it.

6. Program Type (supported in the future)

7. Parts

The sort of the found character string is set.

8. Other Conditions

The other condition is set.

## 4.2 REPLACE

The specified character string is found and replaced in the ladder program.

1. Select **Search (S) - Replace (P)** of the menu or from the pop-up menu.



<Key Operation> : Ctrl + H



2. The dialog box is displayed.

Input the found character string, the replaced character string, and the condition.

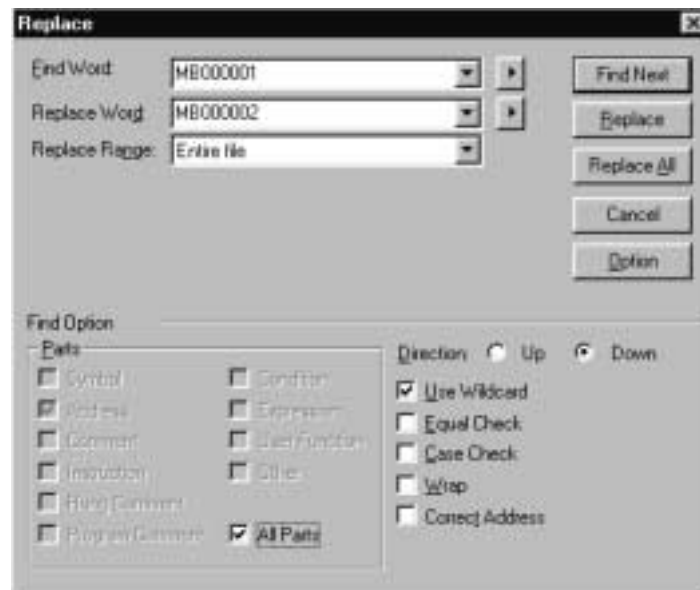

3. Select the Replace button and a specified character string is found according the specified condition and replaced. The cursor is moved to next found position after replaced and it is displayed in the reverse mode when there is a character string that meets it.

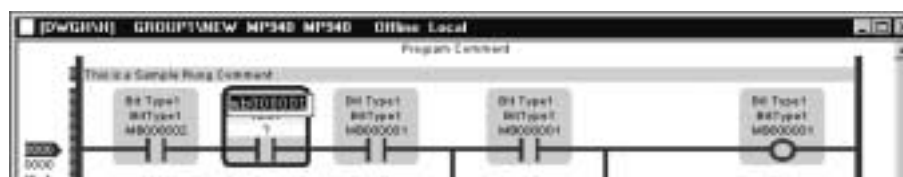

4

4. All specified character strings are found according the specified condition when the Replace All button is selected. The result of replacing is displayed in the output window.

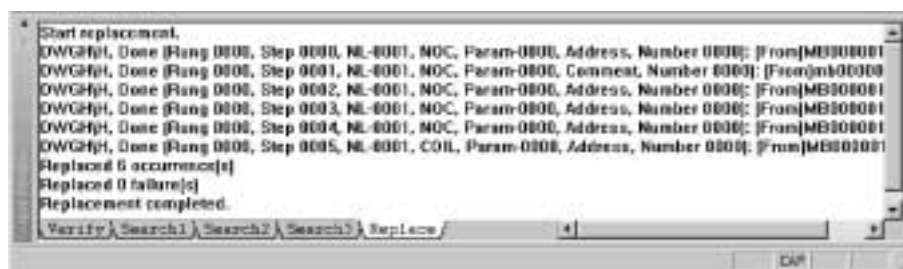

5. Double-click the result of replacing in the pane, the cursor is moved to the specified position in the program and is displayed in the reverse mode.

■ Details of Replace Dialog

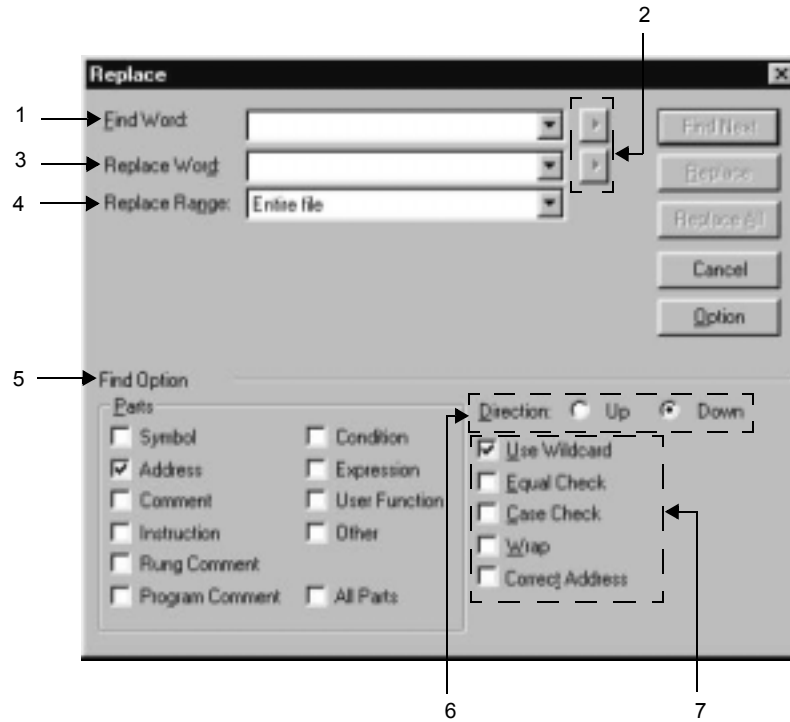

1. Find Word

Input the found character string. The used character strings are displayed in the drop down list and can be used when inputting it.

2. Select Word Dialog Display

This is available when Command is selected.

Select the button and the Select Word dialog box is displayed. The specified instruction is set to the Command input box when clicking the instruction name in it.

The same word is reflected to the Find Word input box in Find dialog box when OK button is selected.

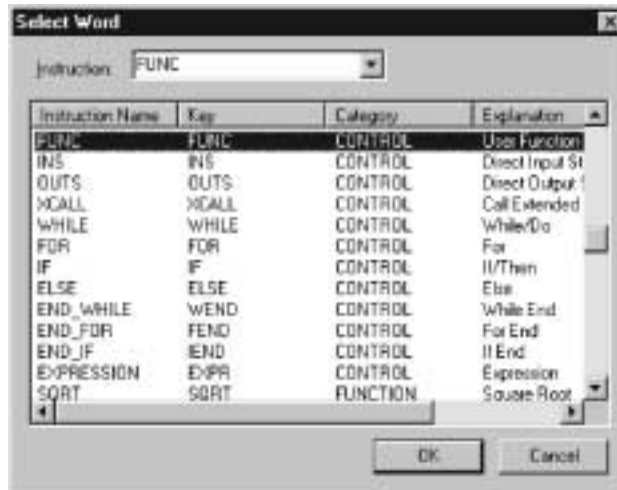

### 3. Replace Word

Input the replaced character string. The used character strings are displayed in the drop down list and can be used when inputting it.

### 4. Range

The replaced range is set.

- File

All specified character strings are replaced in the active program file.

- Selected Range

All specified character strings are replaced in the selected range.

### 5. Parts

The sort of the found character string is set.

### 6. Direction

The direction of searching is set.

### 7. Other Conditions

The other condition is set.

## 4.3 CROSS REFERENCE

The cross reference function is used to search how and in which program a symbol or a register is used.

### 4.3.1 Display Cross Reference Window

The cross reference window is displayed.

1. Select **View (V) - Cross Reference Data (F)** from the menu.
2. The cross reference window is displayed on the ladder editor window in the docked mode.

#### ■ Cross Reference Configuration

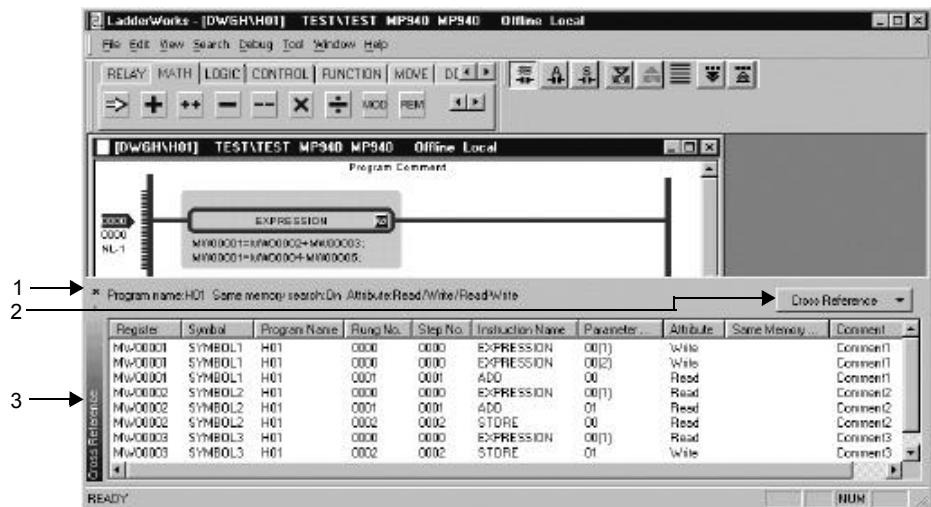

1. Cross reference condition display  
The executive condition of the cross reference is displayed.
2. Menu display button  
The menu of the cross reference function is displayed when the button is clicked.

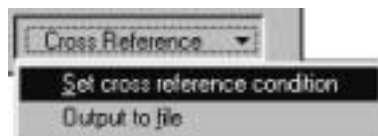

### 3. Result display area

The result of the cross reference is displayed.

Item	Explanation
Address	The register address is displayed.
Symbol	The symbol is displayed.
Program Name	The program name in which the searched object is used is displayed.
Rung Number	The rung number of the searched object is displayed.
Step Number	The step number of the searched object is displayed.
Instruction Name	The instruction name in which the searched object is used is displayed.
Parameter Number	The parameter number of instruction name in which the searched object is used is displayed. When the instruction is EXPRESSION, the line number that includes the searched object in the operational expression is displayed with parentheses.
Attribute	The read or write attribute is displayed.
Use Address	The address is displayed when same memory searching check box is set in the cross reference option.

### ■ Pop-up menu

1. Right-click in the result display area.
2. The pop-up menu is displayed.

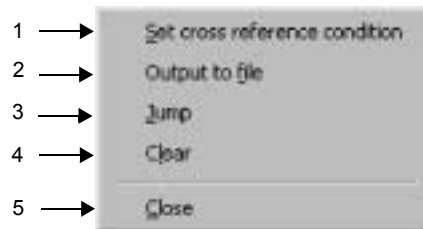

1. ***Set cross reference condition (S)***

The cross reference condition dialog box is displayed.

2. ***Output to file (F)***

The file output dialog is displayed.

3. ***Jump (J)***

Jump to the position in the ladder program that is specified at the cursor position in the searched result.

4. ***Clear (L)***

Clear the result of the cross reference.

5. ***Close (C)***

Close the cross reference window.

### 4.3.2 Cross Reference Condition

The cross reference condition dialog box is displayed from the menu button or the pop-up menu.

In the cross reference condition dialog, the symbol or the register is selected as a cross reference condition. The input item of the screen is different according to the selection.

■ When the symbol is selected

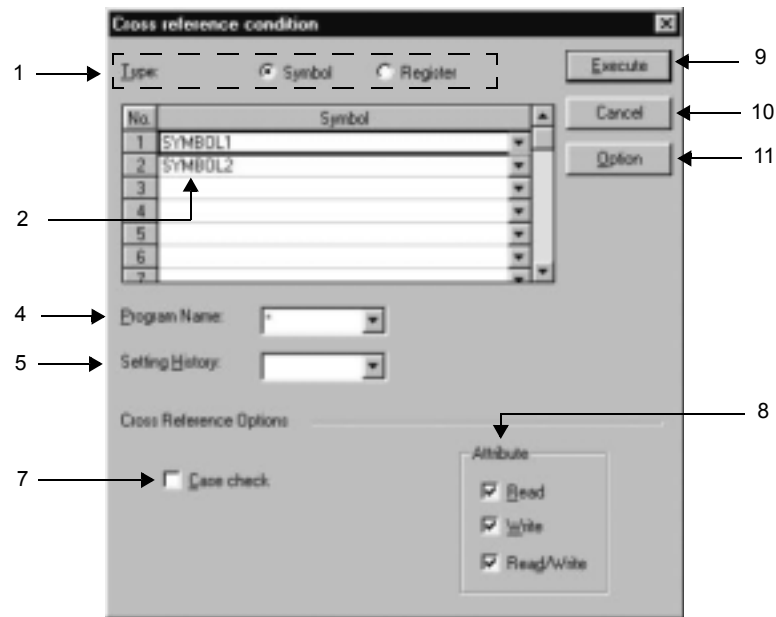

■ When the register is selected

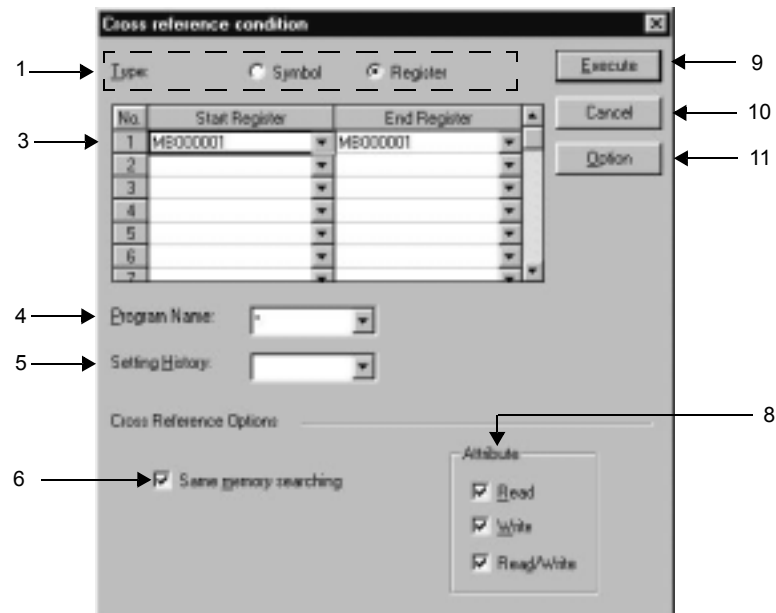



1. Data Type  
Select the symbol or the register.
2. Symbol  
Input the searched symbol name.  
The symbol names can be set up to 30 at the same time.
3. Register  
Input the range (Start Register and End Register) of the searched register.  
Ranges of the register can be set up to 30 at the same time.
4. Program name  
Input the searched program name. The wild-card (\*) is available.  
All H program is searched when H\* is input as a program name.
5. Setting History  
A set condition is selected from the history.  
The set condition input in the past is memorized as the history.  
The latest history becomes "History -1".
6. Same memory searching  
It is available when the register is selected. All registers which use the same memory are searched. For example, when MW00000-MW00010 is specified, MB000000-MB00001F, ML00000-ML00010, and MF00000-MF00010 are also searched.
7. Case check  
It is available when the symbol is selected. The upper case and lower case are distinguished.
8. Attribute  
Set the attribute of the searched symbol or register used in the program.
9. Execute  
Execute the cross reference.
10. Cancel  
Cancel the crossing reference condition dialog.
11. Option  
Display the cross reference options.

◀ EXAMPLE ▶

### 4.3.3 Output to File

The result of the cross reference can be output to the file by Comma Separated Value or the TEXT form.

1. Click Cross Reference button. Or, right-click in the result display area.
2. Select **Output to file (F)**.
3. The file output dialog is displayed.

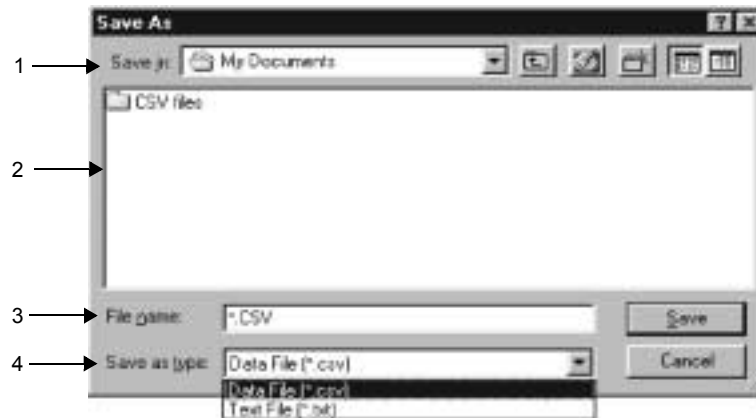

1. Look in  
Select the folder for the output file.
2. File list  
The list of the file is displayed.
3. File name  
Input the output file name.
4. File type  
Select the output file type. Two kinds of the following file type are available.
  - Data Files (\*.csv): Comma Separated Value file
  - Text file (\*.txt): TEXT form file

### ■ CSV File

The result of cross reference is formatted by comma (",") delimitation and output to the file as CSV file (.csv). It is opened and edited easily with a tool such as Excel.

#### ◀ EXAMPLE ▶

#### Output to the CSV File

```
MW00001, Symbol1, Comment1, H01, 0001, 0010, STORE, 00, Write,
MW00001, Symbol1, Comment1, H01, 0002, 0013, STORE, 00, Write,
MW00001, Symbol1, Comment1, H01, 0003, 0020, ADD, 02, Write,
MW00001, Symbol1, Comment1, H02, 0004, 0000, INC, 00, Read-Write,
MW00001, Symbol1, Comment1, H02, 0004, 0100, INC, 00(2), Read-Write,
MW00001, Symbol2, Comment2, H20, 0001, 0005, NOC, 00, Write, MB00001F
```

### ■ Text File

The result of cross reference is output to the file by the character string. It is opened and edited easily with any text editor such as Notepad.

The crossing reference condition data is output to the file as a header with the cross reference result.

#### ◀ EXAMPLE ▶

#### Output to the Text File

Target Order name:GROUP920 PLC name:MP01¥CPU1

Time 2000/09/27 11:45

Cross type Register:MW00000 thru MW00100

File name:H\*

Same memory search:On

Attribute:Read/Write/Read-Write

Register Count Cross reference Symbol Comment

MW00001 4 H01,Rung-0001,Step-0010,STORE,Param-00,Read Symbol1 Comment1

H01,Rung-0002,Step-0013,STORE,Param-00,Read

H01,Rung-0003,Step-0020,ADD,Param-02,Write

H20,Rung-0001,Step-0011,NOC,Param-00,Read,MB00001F

MW00050 3 H02,Rung-0000,Step-0000,INC,Param-00,Read-Write Symbol2 Comment2

H02,Rung-0001,Step-0001,EXPRESSION,Param-00(2),Read

H02,Rung-0001,Step-0001,EXPRESSION,Param-00(2),Write

---

## SYMBOL DATABASE

The symbol database offers the function to manage the symbol to the register and the data of the comment etc. and also offers the method of data acquisition of the ladder editor's not depending on the controller type.

<b>5.1 SYMBOL MANAGER</b>	<b>-----5-2</b>
5.1.1 Symbol Manager Menu	----- 5-2
5.1.2 Data Tree	----- 5-3
<b>5.2 SYMBOL LIST</b>	<b>-----5-4</b>
5.2.1 Symbol List	----- 5-4
5.2.2 Add Symbol	----- 5-6
5.2.3 Insert Symbol	----- 5-7
5.2.4 Delete Symbol	----- 5-8
5.2.5 Import Symbol Data	----- 5-9
5.2.6 Export Symbol Data	----- 5-10
5.2.7 Find/Replace	----- 5-11
<b>5.3 REGISTER MAP</b>	<b>----- 5-16</b>
5.3.1 Register Map	----- 5-16
<b>5.4 AUTOMATIC ADDRESS ALLOCATION</b>	<b>----- 5-18</b>
5.4.1 Automatic Address Allocation	----- 5-18
5.4.2 Setting of Register Area	----- 5-19
5.4.3 Execution of Automatic Address Allocation	----- 5-20
<b>5.5 OPERATION IN LADDER EDITOR</b>	<b>----- 5-21</b>
5.5.1 Display Symbol List	----- 5-21
5.5.2 Display Register Map	----- 5-23
5.5.3 Unregistered Symbol List	----- 5-26

## 5.1 SYMBOL MANAGER

The symbol manager is composed as MDI application that consists of the three windows such as the symbol list, the register map, and the data tree window.

1. Select **Tool (T) - Symbol System (S) - Symbol Manager (S)** of the menu.



2. The symbol manager is started and the only Data Tree window is displayed.

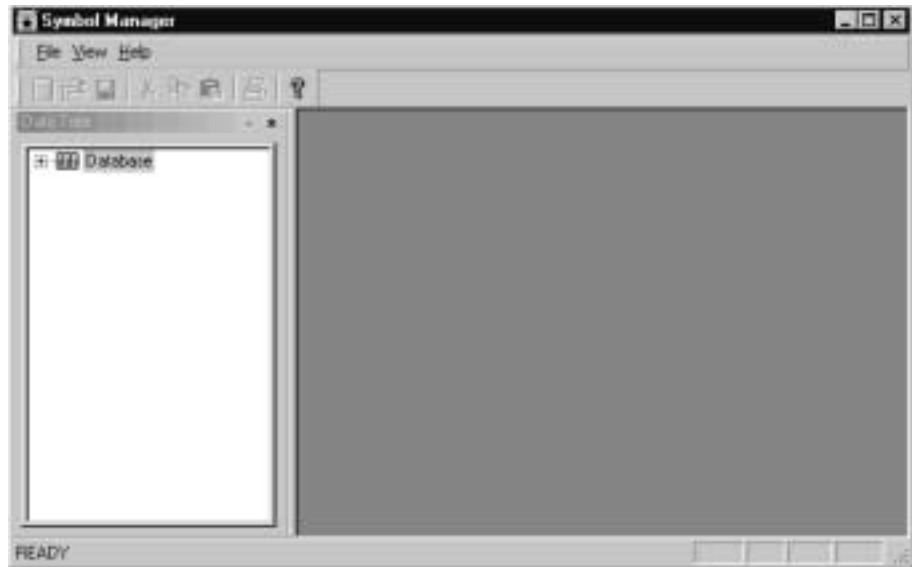

### 5.1.1 Symbol Manager Menu

The edit functions of the symbol manager are prepared in the menu. The functions often used in the menu are prepared on the tool bar.

## 5.1.2 Data Tree

The data structure in the database is displayed in the data tree.

Select the items such as the Symbol List window, the Register Map window and Automatic Address Allocation window in the data tree to access the data. The selected window is displayed.

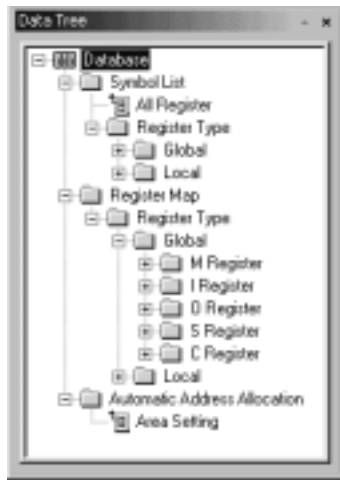

## 5.2 SYMBOL LIST

The content of the registered symbols is referred and defined in the symbol list.

### 5.2.1 Symbol List

Double-click the All list on the Symbol List folder in the Data Tree Window and the registered symbol list is displayed.

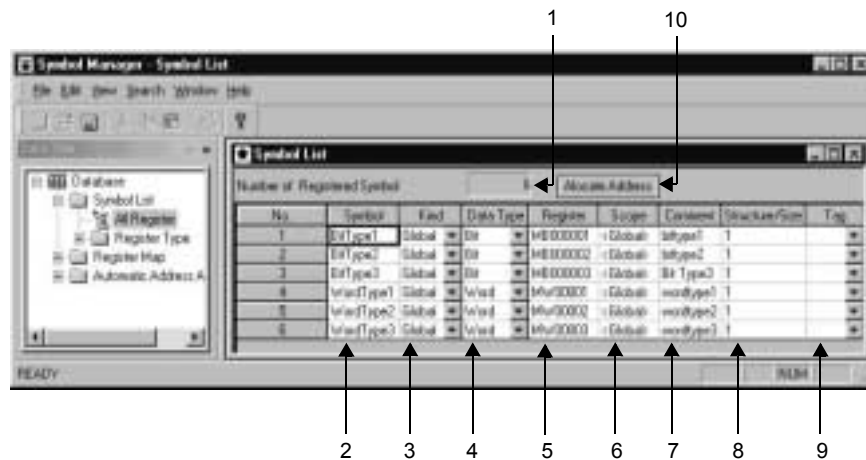

#### 1. Number of Registered Symbol

The number of the registered symbol is displayed.

#### 2. Symbol

The symbol of the instruction is displayed and can be input. The length of the symbol is up to the normal-width 64 characters.

#### 3. Kind

The kind of register is displayed and can be selected.

- Global : M register
- System : S register
- Const : C register
- Input : I register
- Output : O register
- Local : D register
- LocalConst : # register

#### 4. Data Type

The data type of register is displayed and can be selected.

- Bit : Bit type
- Word : Integer type
- Long : Double Integer-type
- Float : Real type
- Address : Address type

#### 5. Register

The register address of the instruction is displayed and can be input.

6. Scope

In the case of local register, the program name or the function name is displayed and can be input. In the other case, "Global" is displayed.

7. Comment

The comment is input. The length of the comment is up to the normal-width 100 characters.

8. Struct/Size

The name of the structured definition or the size of register is displayed.

9. Tag

The tag name when the register is allocated by the Automatic Address Allocation is displayed.

10. Allocate Address button

The Automatic Address Allocation is executed, and the register is allocated in the symbol.



## 5.2.2 Add Symbol

The new symbol definition is added to the symbol list.

1. Select **Edit (E) - Add (A)** of the menu.

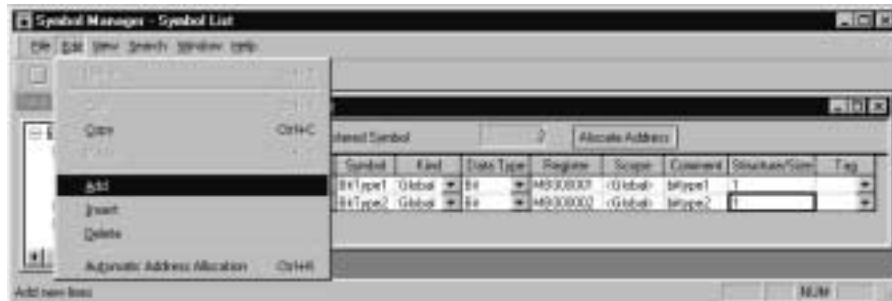

2. A new symbol definition data is added in the bottom of the symbol list.

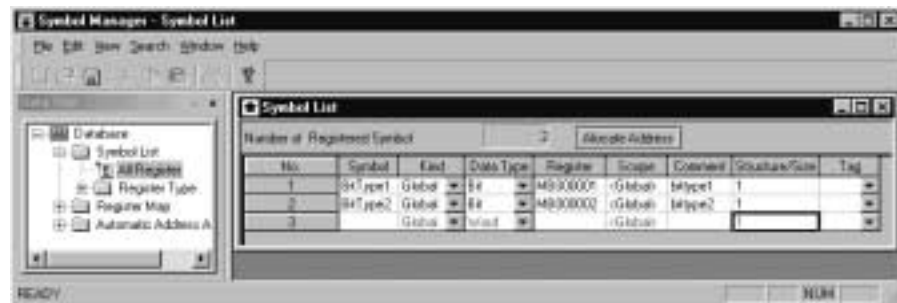

3. Select **File (F) - Save (S)** of the menu after inputting data.

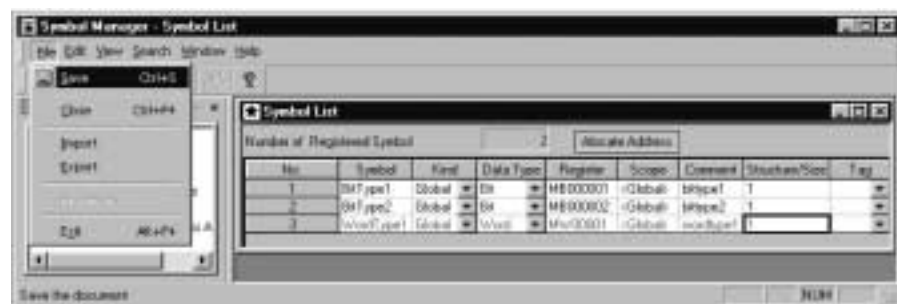

4. The message is displayed and the registration of new symbol is completed.

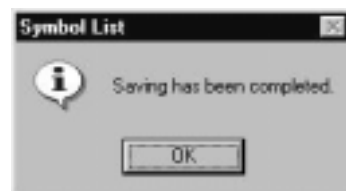

### 5.2.3 Insert Symbol

The new symbol definition is inserted to the symbol list.

1. Select **Edit (E) - Insert (I)** of the menu.

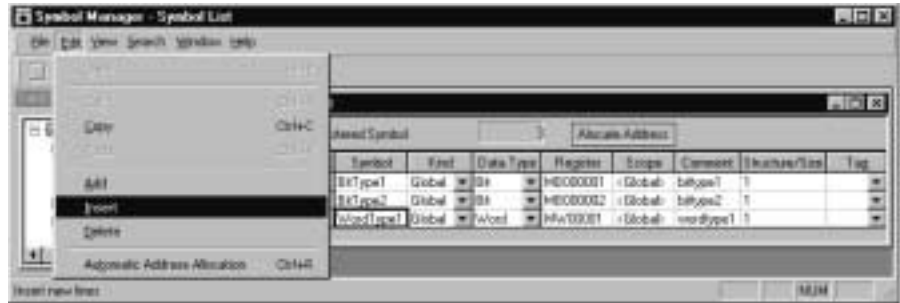

2. A new symbol definition data is inserted on the cursor position in the symbol list.

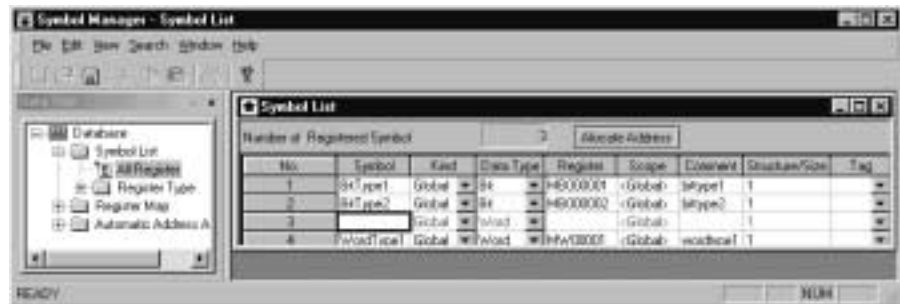

3. Select **File (F) - Save (S)** of the menu after inputting data.

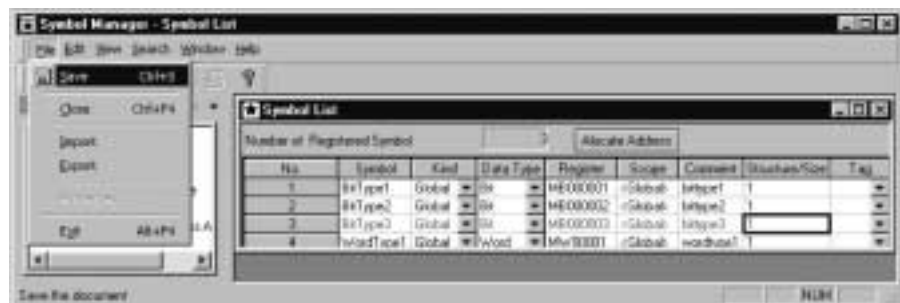

4. The message is displayed and the registration of new symbol is completed.

## 5.2.4 Delete Symbol

The selected symbol definition is deleted in the symbol list.

1. Move the cursor to the deleted symbol definition data and select **Edit (E) - Delete (D)** of the menu.



<Key Operation>: Delete



2. The symbol definition data on the cursor position is deleted and the following lines are shifted up by one step.
3. Select **File (F) - Save (S)** of the menu.



<Key Operation>: Ctrl + S

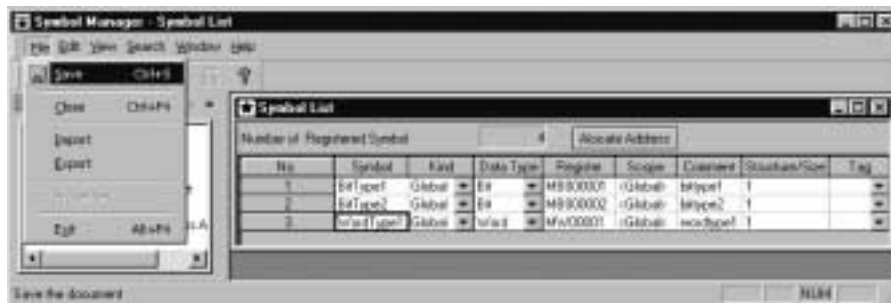

4. The message is displayed and the registration of new symbol is completed.

## 5.2.5 Import Symbol Data

The symbol data is imported from CSV data file.

1. Select **File (F) - Import (I)** of the menu and the Open dialog box is displayed.

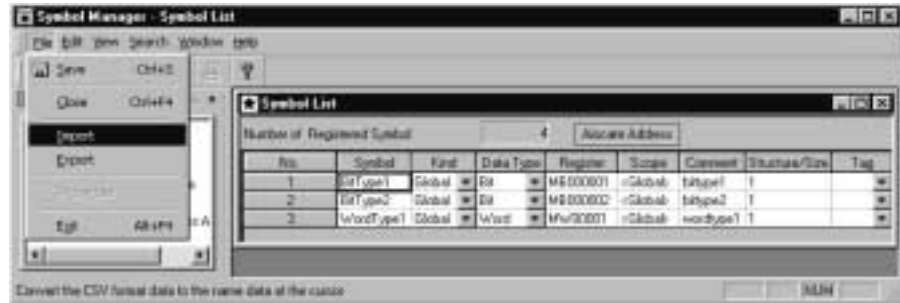

2. Select the imported CSV data file.



3. The data of the selected CSV data file is reflected to the symbol list and displayed on the cursor position.

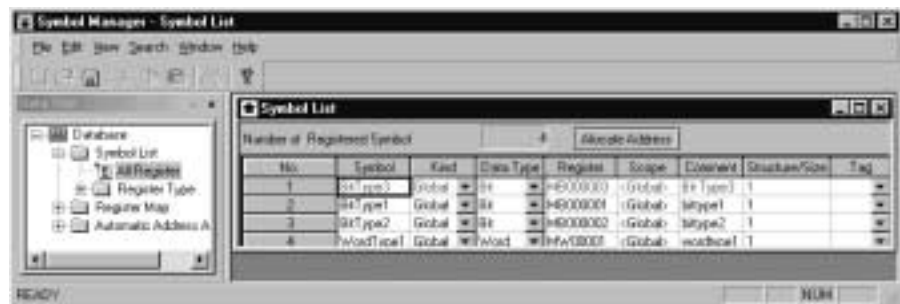

## 5.2.6 Export Symbol Data

The symbol data in the symbol list is exported to CSV data file.

1. Select **File (F) - Export (E)** of the menu and the Save As dialog box is displayed.

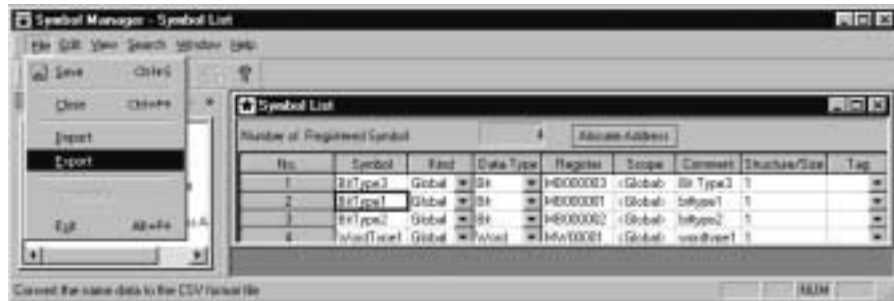

2. Set the name of the exported CSV data file, and select **Save (S)** button.

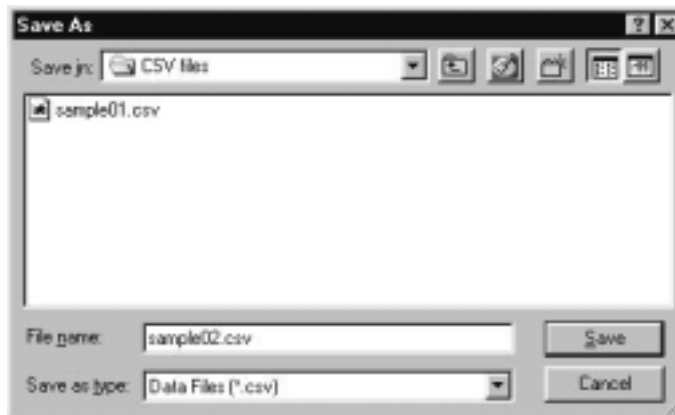

3. The selected one or more symbol data is exported to the specified file.

## 5.2.7 Find/Replace

The specified character string is found and replaced in the Symbol List.

### ■ Find

The specified character string is found in the displayed Symbol List.

1. Select **Search (S) - Find (F)** of the menu or from the pop-up menu.



< Key Operation >: Ctrl + F

2. The dialog box is displayed. Input the found character string and the condition.

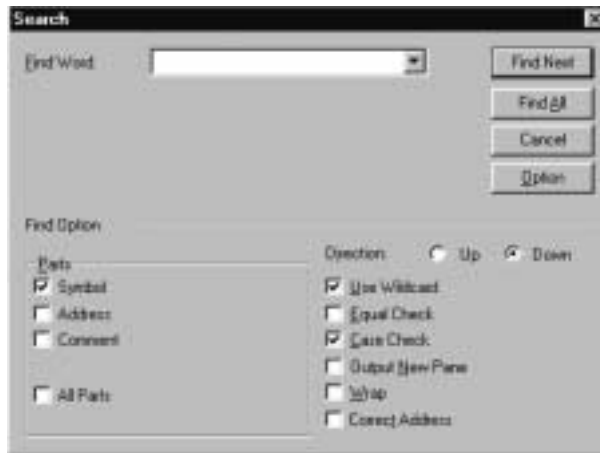

Select the Find Next button and a specified character string is found according the specified condition. The cursor is moved to its position and it is displayed in the reverse mode when there is a character string that meets it.

3. All specified character strings are found according the specified condition when the Find All button is selected. The result of searching is displayed in the output window.

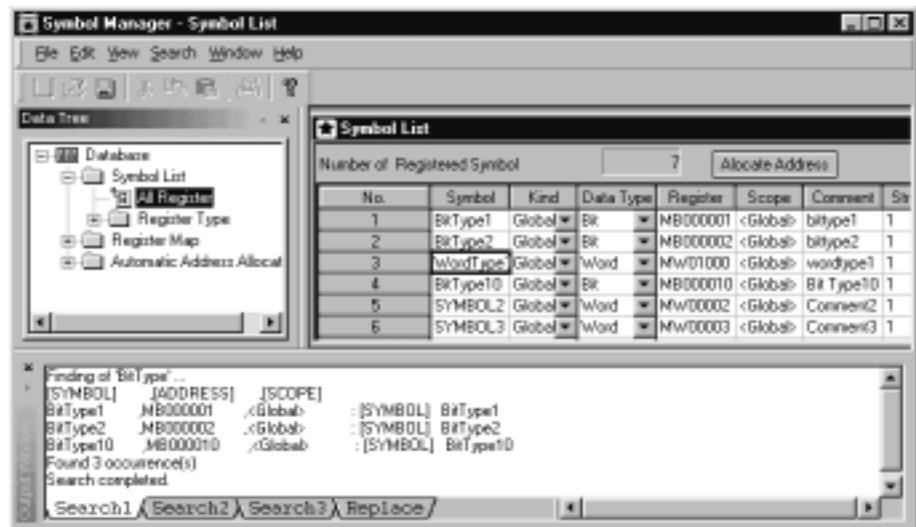



3 panes for finding displayed in the output window are prepared. The result of searching is usually displayed in the Search 1 pane and it is displayed in another pane when [Output New Pane] is checked.

4. Double-click the result of searching in the pane, the cursor is moved to the specified position in the program and is displayed in the reverse mode.

## ■ Details of Find Dialog

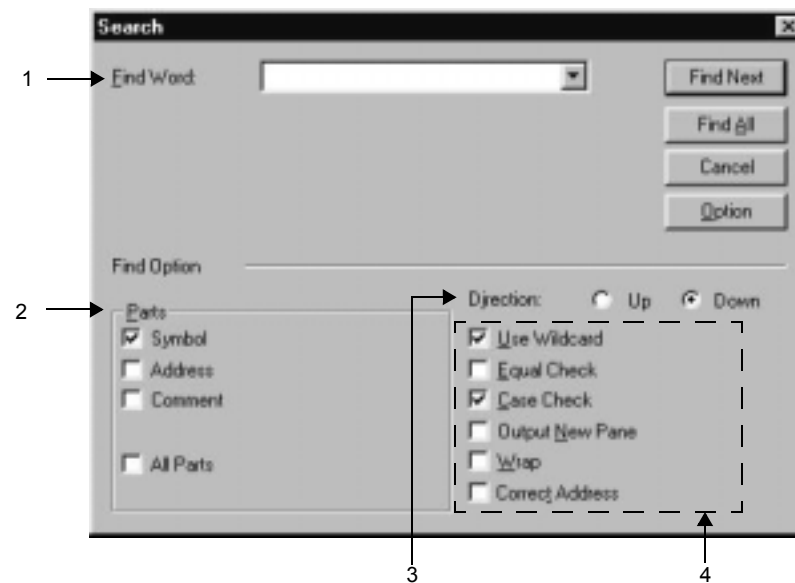

### 1. Find Word

Input the found character string. The used character strings are displayed in the drop down list and can be used when inputting it.

### 2. Parts

The sort of the found character string is set.

### 3. Direction

The direction of searching is set.

### 4. Other Conditions

The other condition is set.

- Use Wildcard

Wild-card (\*,?) is made effective.

- Equal Check

The character string to which the whole is corresponding is found.

- Case Check

The capital letter and the small letter of the input character string are distinguished.

- Output New Pane.

When the Find All button is selected, the result of searching is displayed in the output

window as a new pane.

- Wrap

The cursor position wraps the entire file when the Find Next button is pushed and the searching is ended.

- Correct Address

When the Address check box of Parts turns on, The register address input is corrected to regular shape. For instance, MW1 is corrected to MW00001.

## ■ Replace

The specified character string is found and replaced in the Symbol List.

1. Select **Search (S) - Replace (P)** of the menu or from the pop-up menu.



< Key Operation >: Ctrl + H

2. The dialog box is displayed.

Input the found character string, the replaced character string, and the condition.

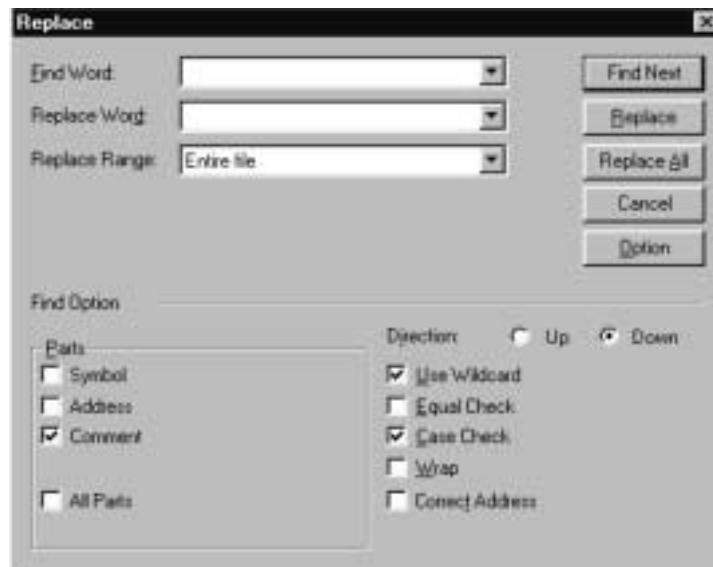

3. Select the Replace button and a specified character string is found according the specified condition and replaced. The cursor is moved to next found position after replaced and it is displayed in the reverse mode when there is a character string that meets it.
4. All specified character strings are found according the specified condition when the Replace All button is selected. The result of replacing is displayed in the output window.



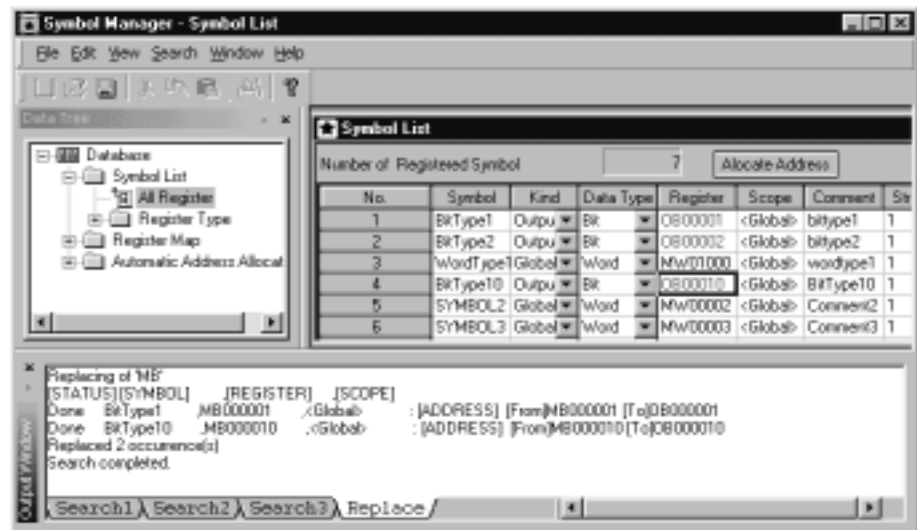

5. Double-click the result of replacing in the pane, the cursor is moved to the specified position in the program and is displayed in the reverse mode.

## ■ Details of Replace Dialog

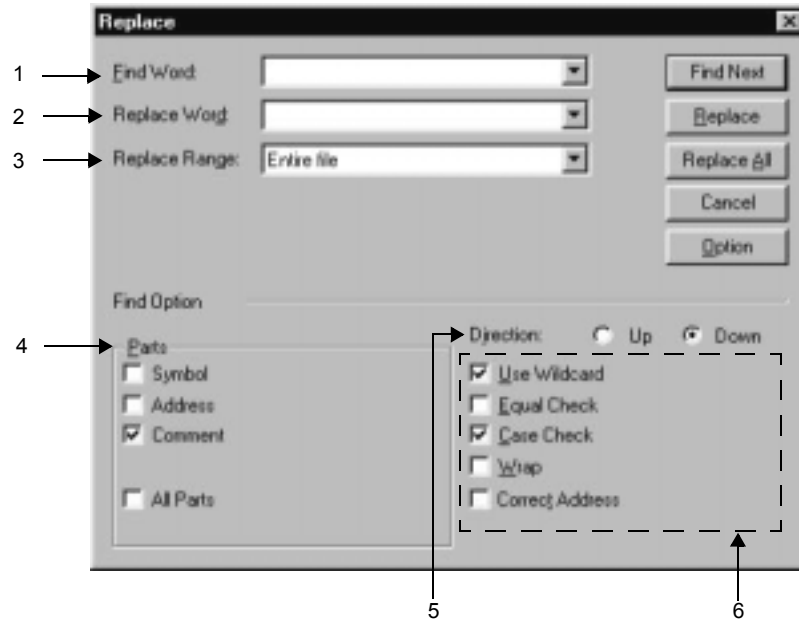

### 1. Find Word

Input the found character string. The used character strings are displayed in the drop down list and can be used when inputting it.

### 2. Replace Word

Input the replaced character string. The used character strings are displayed in the drop down list and can be used when inputting it.

### 3. Range

The replaced range is set.

- File

All specified character strings are replaced in the Symbol List.

- Selected Range

All specified character strings are replaced in the selected range.

### 4. Parts

The sort of the found character string is set.

### 5. Direction

The direction of searching is set.

### 6. Other Conditions

The other condition is set.

## 5.3 REGISTER MAP

The presence of the symbol for the register is arranged according to the data type and displayed in the register map.

### 5.3.1 Register Map

Double-click the each list on the Register folder in the Data Tree window and the register map is displayed. The displayed screen is different in a global register and a local register.

#### ■ Local Register

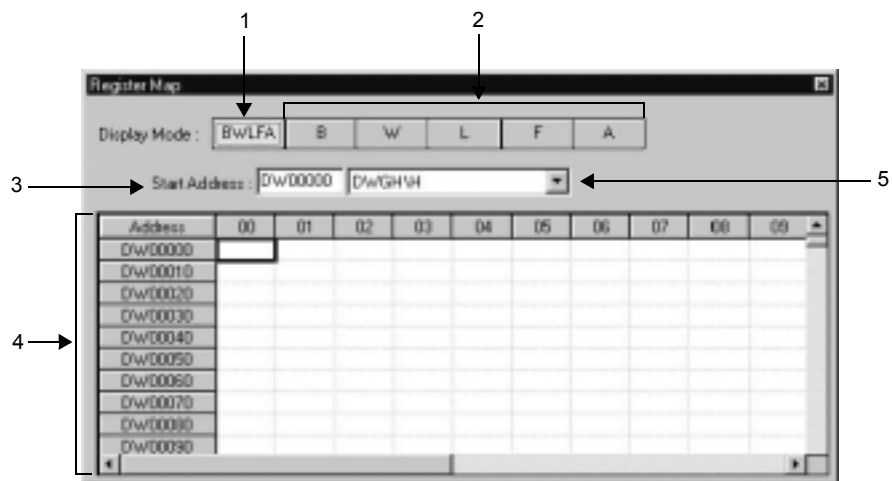

#### ■ Global Register

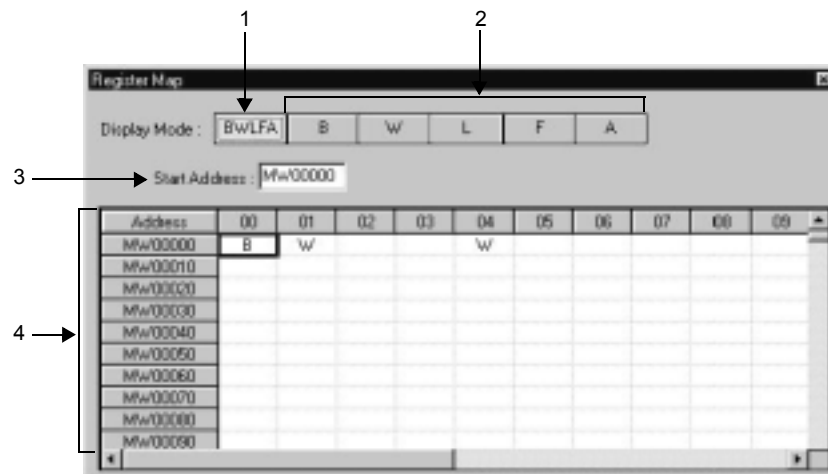

## Display Mode

### 1. BWLFA button

The presence of the symbol for the register is displayed all data type such as bit type, integer type, double integer type, real type, and address type simultaneously. The data type in which the symbol is defined is displayed in each cell by combining alphabets.

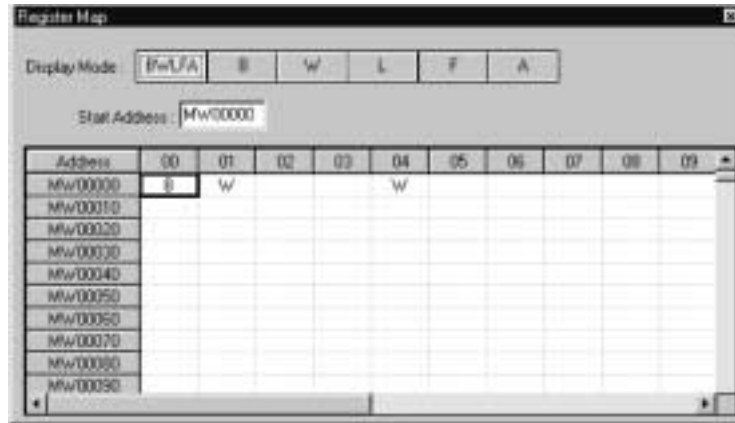

### 2. Other buttons

The presence of the symbol for the register is displayed each data type. The "\*" mark is displayed when the symbol is defined.

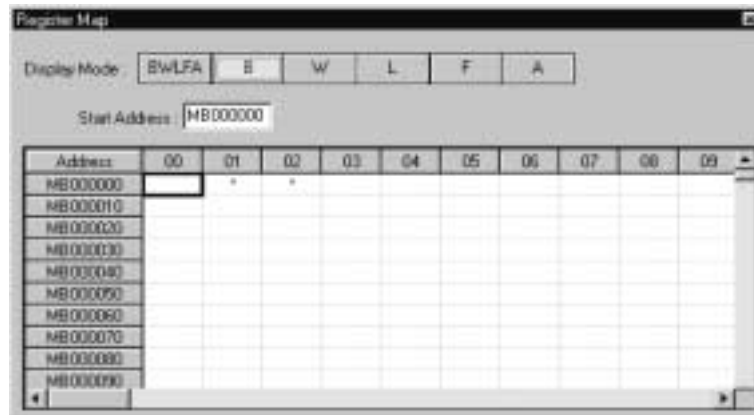

### 3. Start Address

The start address of the displayed register is set. The cursor is moved to the specified register address cell.

### 4. Address

The addresses of register are displayed from the specified start address.

### 5. Scope

The program name or the function name is displayed and can be input.

## 5.4 AUTOMATIC ADDRESS ALLOCATION

An automatic address allocation is a function to allocate register address in the symbol automatically.

The address of the register used for the automatic allocation should set the address area on the Automatic Address Allocation window. An automatic address allocation to the symbol becomes possible by the automatic address allocation function of the Symbol List.

### 5.4.1 Automatic Address Allocation

Double-click the Area Setting file on the Automatic Address Allocation folder in the Data Tree window and the Automatic Address Allocation window is displayed.

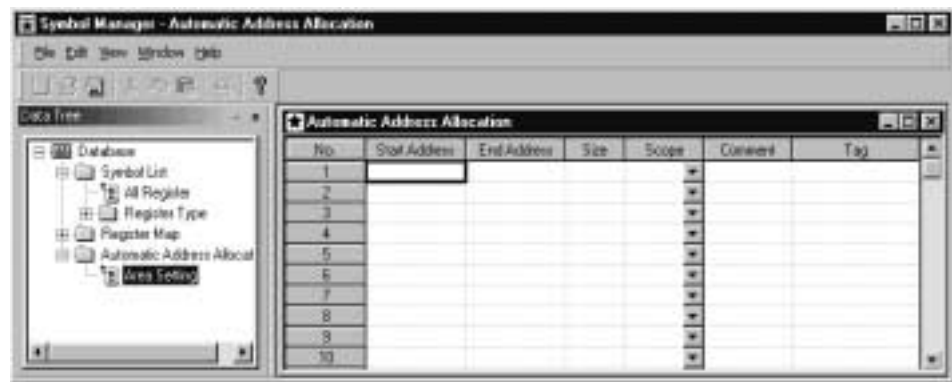

#### 1. Start Address

The start address in the target area for an automatic address allocation is displayed and can be input.

#### 2. End Address

The end address in the target area for an automatic address allocation is displayed and can be input.

#### 3. Size

The number of words of the target area for an automatic address allocation is displayed and can be input.

#### 4. Scope

In the case of local register (D register), the program name or the function name is displayed and can be input. In another case, Global (M register) is displayed.

#### 5. Comment

The comment is input. The comment set here becomes a comment which is used on the automatic numbering function of the Symbol List. The length of the comment is up to the normal-width 100 characters.

#### 6. Tag

The tag name to the target area for an automatic address allocation is displayed and can be input.

## 5.4.2 Setting of Register Area

The target register area for an automatic address allocation is set.  
Setting data can be edited by the menu (cut , copy, paste, and delete).

1. Input the data to the item.

It is automatically adjusted by inputting either End Address or Size.

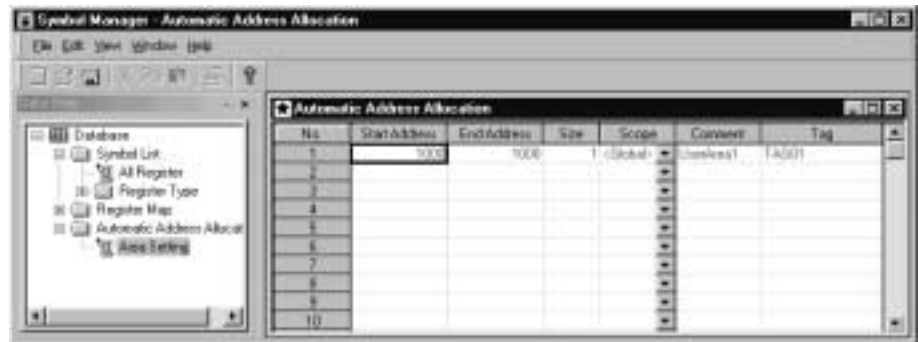

2. The edit menu is selected from **Edit (E)** of the menu.



3. Select **File (F) - Save (S)** of the menu after inputting data.

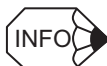

<Key Operation >: Ctrl + S

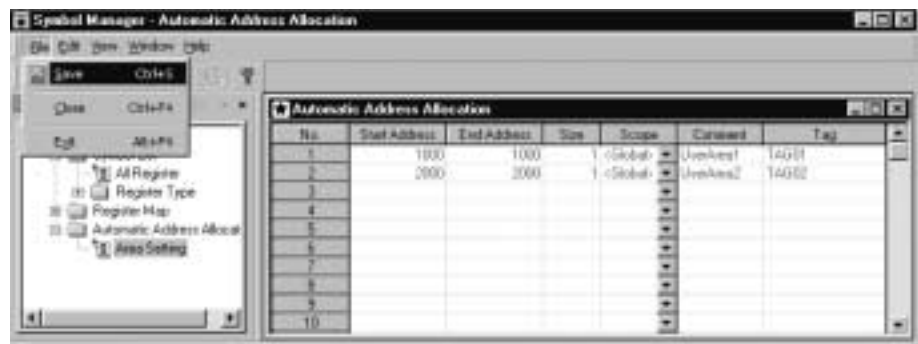

4. The message is displayed and the setting of register area is completed.

## 5.4.3 Execution of Automatic Address Allocation

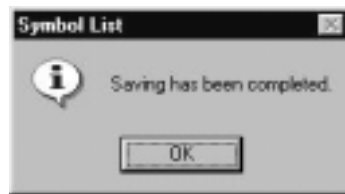

## 5.4.3 Execution of Automatic Address Allocation

The automatic address allocation to the symbols is executed in the Symbol List.

1. Open the Symbol List, and set Tag name of the symbol where the register is not allocated.

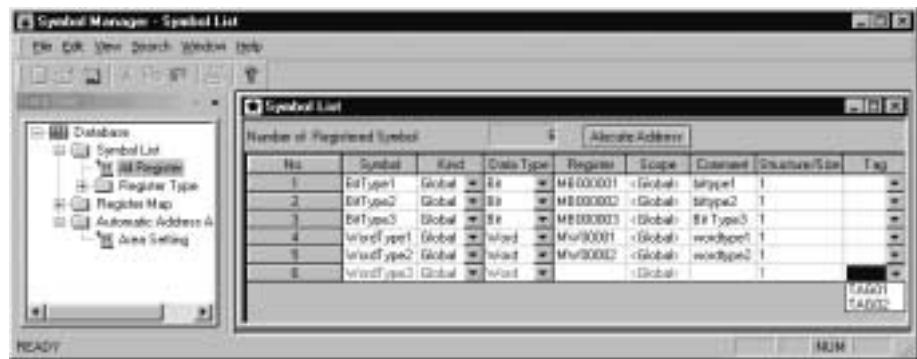

2. Select **Edit (E) - Automatic Address Allocation (T)** or the Allocate Address button.



3. The register is automatically allocated to the symbol.

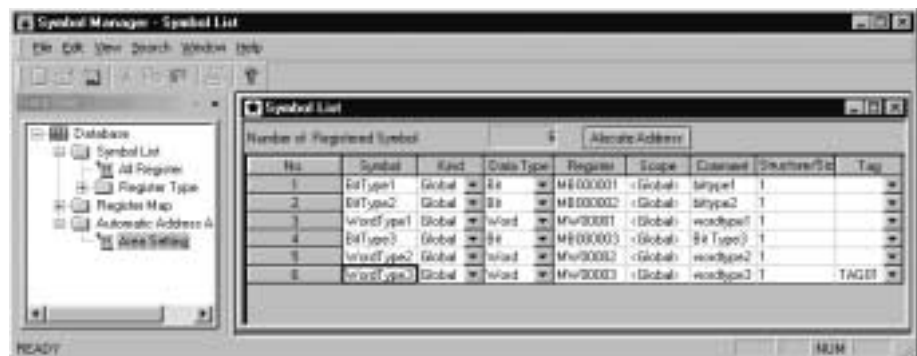

## 5.5 OPERATION IN LADDER EDITOR

### 5.5.1 Display Symbol List

1. Select **Tool (T) - Symbol System (S) - Symbol List (L)** from the menu.

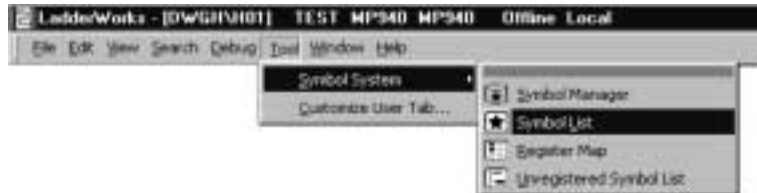

2. The symbol list is displayed in the ladder editor. It can be edited.



Open the symbol list from the symbol manager if the edit operation is required.

#### ■ Search

The search function is opened in the symbol list.

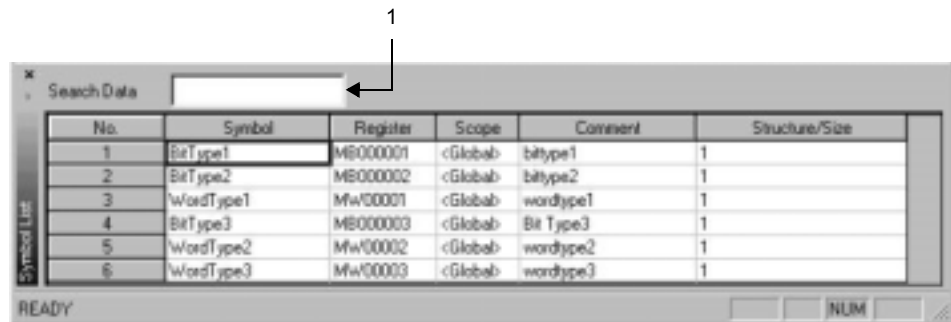

1. Search Data

Input the specified data. The cursor immediately moves to the position that input data shows.

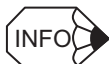

1. Click the title of each item of the symbol list, the data is sorted.
2. The upper case and lower case are not distinguished.
3. The wild card (\*) is not available.

#### ■ Using Function Key

Search the specified data using the function key.

1. Select F12, and then the symbol list is displayed.
2. Select F9, and then the specified data is sorted.



3. Select F2, and then the specified data is put in editing.
4. Select F5, and then the cursor moves to next data.

### ■ Input Symbol Data to Ladder Program

1. Select the specified symbol in the symbol list.
2. Right-click on it and select **Copy (C)** of the menu.

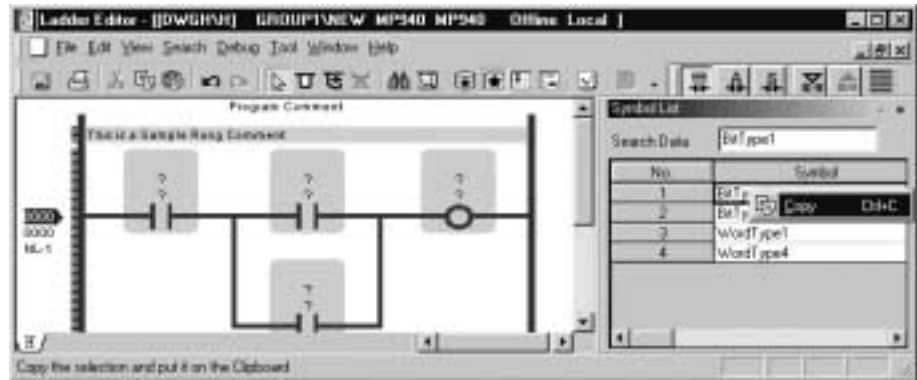

3. Select the instruction that requires the symbol in the ladder program.
4. Right-click on it, and select **Paste (P)**.
5. The data of the symbol list is input to the specified instruction in the ladder program.

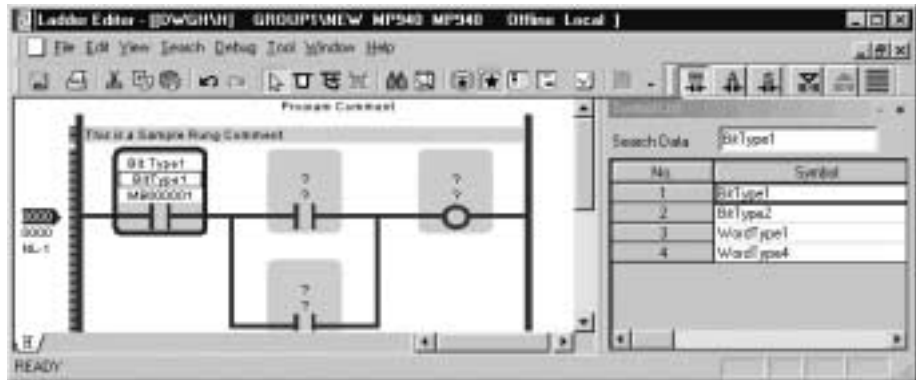

The shortcut keys are as follows.

**Copy (C)** : Ctrl + C, **Paste (P)** : Ctrl + V

Switch the activated screen using function keys such as F11 and F12. Select F11, and then the ladder program is activated. Select F12, and then the symbol list is activated.

## 5.5.2 Display Register Map

1. Select **Tool (T) - Symbol System (S) - Register Map (R)** of the menu in the ladder editor.

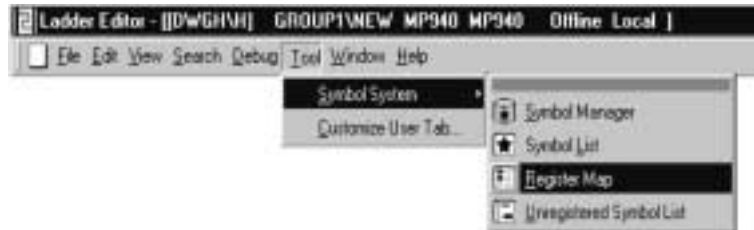

2. The register map window is displayed on the program window as the docking view.

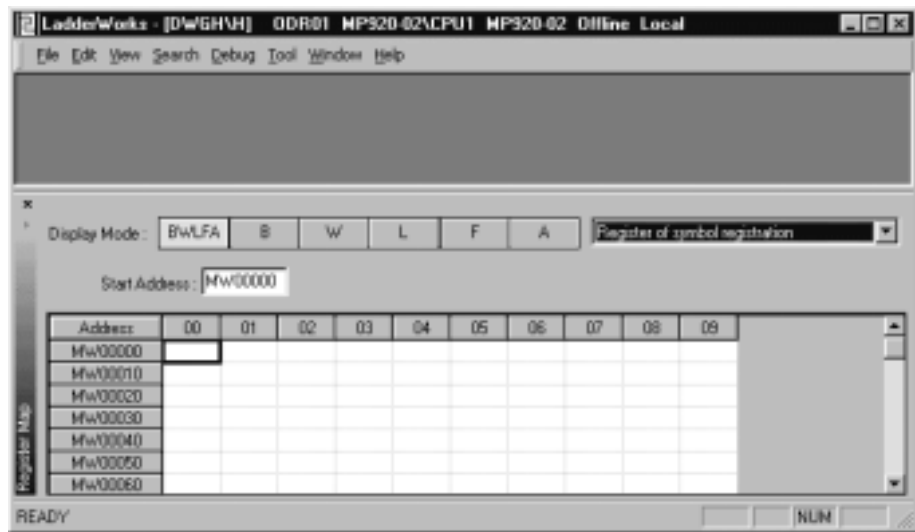

3. The map of the register used by the program is displayed.

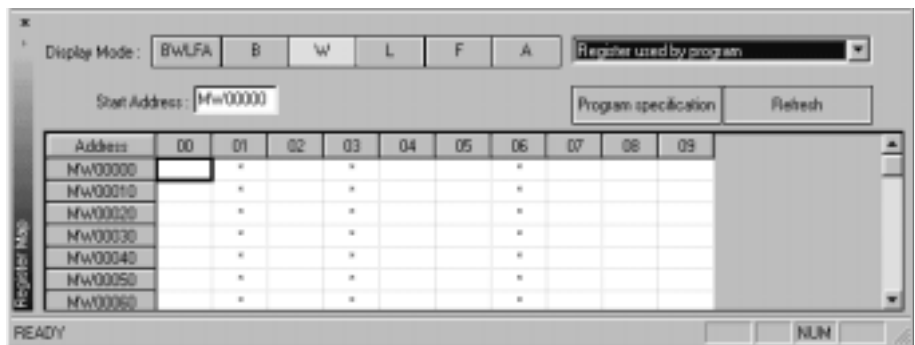

4. Click the Program specification button, and select the programs.

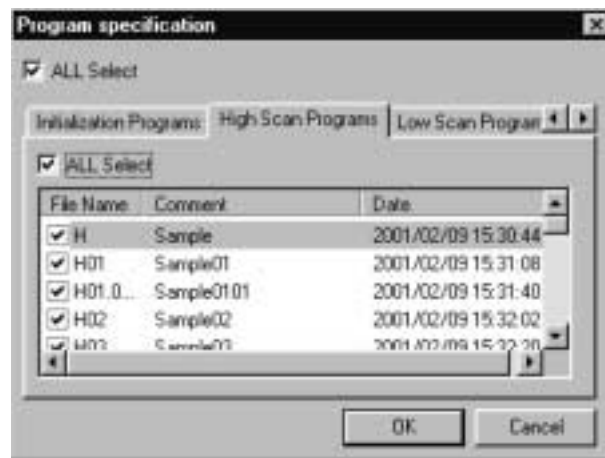

Click the Refresh button, then Register Map is refreshed.

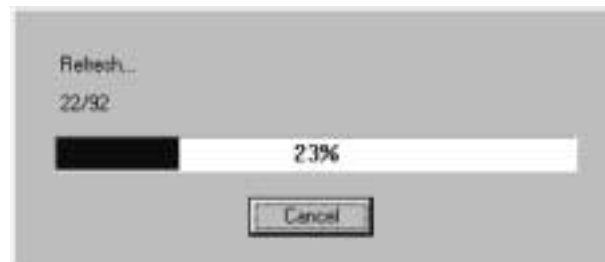

5. Click the Display Mode button, then display mode is changed.

- BWLFA button

The presence of the symbol for the register is displayed all data type such as bit type (B), integer type (W), double integer type (L), real type (F), and address type (A) simultaneously. The data type in which the symbol is defined is displayed in each cell by combining alphabets

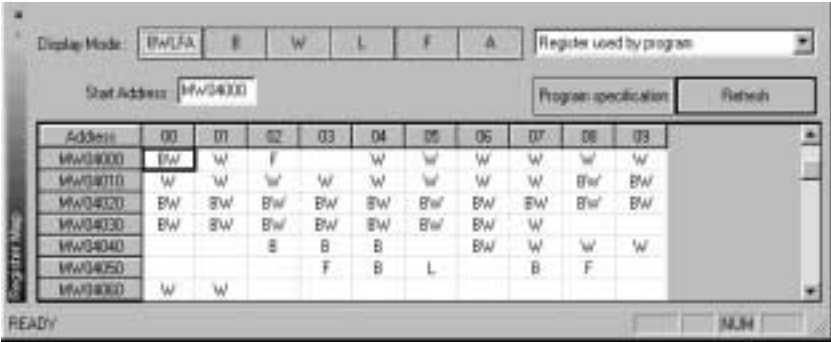

- Other buttons

The presence of the symbol for the register is displayed each data type. The "\*" mark is displayed when the symbol is defined.

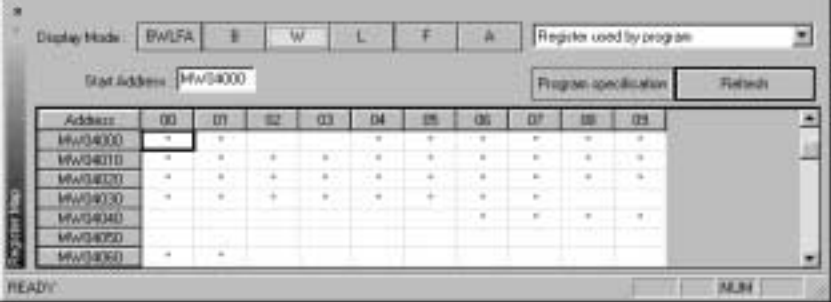

### 5.5.3 Unregistered Symbol List

The new symbols in the ladder program are assigned to the unregistered symbol list. The unregistered symbol can be assigned to the symbol database in the unregistered symbol list.

#### ■ Display Unregistered Symbol List

1. Select **Tool (T) - Symbol System (S) - Unregistered symbol list (U)** from the menu.

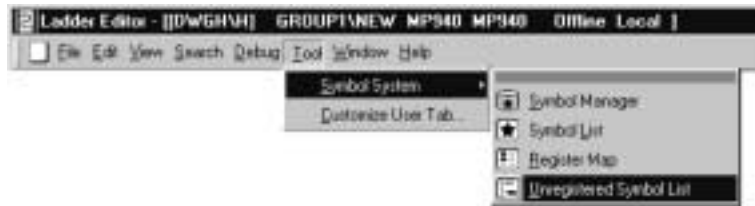

2. The unregistered symbol list window is displayed in the docked mode. The symbols that have not been registered to the symbol database can be viewed.

The screenshot shows the LadderWorks interface with a ladder logic diagram and the 'Unregistered Symbol List' window docked at the bottom. The ladder logic diagram shows a network with a normally open contact labeled '0000 0000 NL-1' on the left, followed by a normally closed contact 'bitype1 B#Type1 MB000001', a normally open contact 'bitype2 B#Type2 MB000002', a normally open contact 'bitype3 B#Type3 MB000003' in parallel with the previous one, a normally closed contact 'bitype4 B#Type4 MB000004', and a coil 'bitype5 B#Type5 MB000005' on the right.

The 'Unregistered Symbol List' window shows the following table:

No.	Unregistered Symbol	Kind	Data Type	Register	Scope	Comment	Struct/Size	Tag
1	BitType1	Global	Bit	MB000001	<Global>	bitype1	1	
2	BitType4	Global	Word		DWGHVH	bitype4	1	
3	BitType5	Global	Word		DWGHVH	bitype5	1	
4	BitType2	Global	Bit	MB000002	<Global>	bitype2	1	
5	BitType3	Global	Bit	MB000003	<Global>	bitype3	1	

At the bottom of the window, there are buttons for 'ALL Select', 'Update', 'Export', and 'Allocate Address'. The status bar at the bottom left shows 'READY' and the bottom right shows 'NUM'.

## ■ Unregistered Symbol List

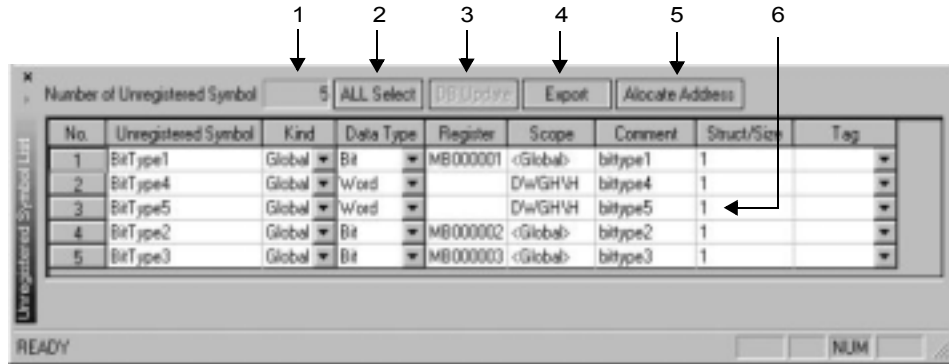

### 1. Number of unregistered symbols

The total number of the unregistered symbol is displayed.

### 2. All select

Select all unregistered symbols.

### 3. DB update

Assign the selected unregistered symbol to the symbol database.

### 4. Export

Export the symbol list to a CSV file. Please refer to paragraph "5.2.6 Export Symbol Data" for the operation procedure.

### 5. Allocate address

Register address is automatically allocated to the symbol which the register is not allocated.

Refer Automatic Address Allocation for this function.

### 6. Unregistered symbol list

The unregistered symbols are displayed, sorted and can be edited.

## ■ DB Update

### 1. Select the unregistered symbol to be assigned to the symbol database.

### 2. Click the DB Update.

### 3. The unregistered symbol is assigned to the symbol database and the symbol database is updated.

---

## DEBUGGING

A monitoring and debugging the ladder program, a displaying the current value, a synchronized collection of current value, and the setting disable coil instruction are explained.

6.1 BASIC FUNCTION	6-2
6.1.1 Display Current Values	6-2
6.1.2 SYNC	6-3
6.1.3 HOLD (supported in the future)	6-4
6.2 DISABLE COILS	6-5
6.2.1 Display	6-5
6.2.2 Set Disable ON	6-6
6.2.3 Set Disable OFF	6-6
6.2.4 Cancel Disable	6-7
6.3 REFER	6-8
6.3.1 Refer on the SEE Instruction	6-8
6.3.2 Refer on the FUNC Instruction	6-9
6.4 QUICK REFERENCE	6-10
6.4.1 Display	6-10
6.4.2 Register List Page	6-11
6.4.3 Watch Page	6-14
6.4.4 The definition data is added from the ladder editor.	6-17
6.5 CURRENT VALUE MONITOR	6-18
6.5.1 Display of Current Value Monitor Window	6-18
6.5.2 Start and Stop Current Value Monitor	6-21
6.5.3 Pop-up Menu	6-22

## 6.1 BASIC FUNCTION

The following functions are valid for monitoring/debugging.

- Current value display
- SYNC function
- HOLD function (supported in the future)

### 6.1.1 Display Current Values

In the online mode, the current values can be displayed at the same time as the program displayed. The current values are renewed constantly and the newest data will be displayed. The current value of each instruction is as follows.

#### ■ Contact

The open/close status of a contact is displayed in the program. The close status is distinguished from the different color.



#### ■ Coil

The energized/de-energized status of a coil is displayed in the program. The energized status is distinguished from the different color.





## ■ Operand

The value of the operand for an operation is displayed below the format.

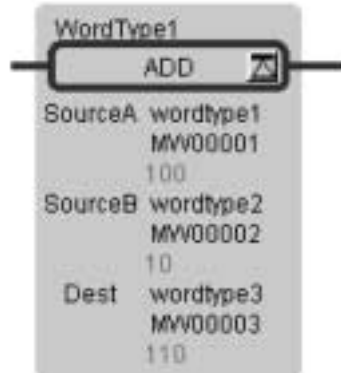

Select **Tool (T) - Editor Option (E)** of the menu to set the color.

### 6.1.2 SYNC

The SYNC is available in only the on-line mode. Its operation is disabled in the off-line mode.

The current values of a program at the time at which the specified register (S, I, O, M, D, C, #) or a subscript register I or J takes on certain value or when the ON/OFF condition of a designated relay No. is satisfied can be displayed. The current value display is renewed when the designated condition is satisfied and will remain the same if condition is not satisfied. Up to 2 synchronization conditions may be set. If two conditions are set, an AND condition is used.

1. Select **Debug (D) - SYNC (S)** of the menu.



## 6.1.3 HOLD (supported in the future)

2. The dialog box is displayed.

Input the required data and set the check box, and select Set button .

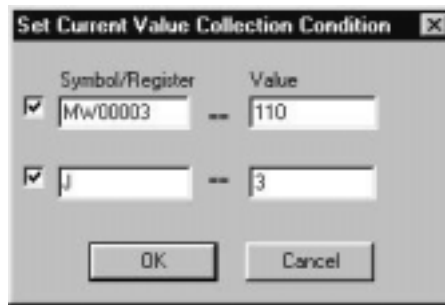

3. The current value display is renewed when the designated condition is satisfied and remains the same if the condition is not satisfied.

## 6.1.3 HOLD (supported in the future)

The collecting current values are stopped temporarily.

1. Select **Debug (D) - HOLD (H)** of the menu.



2. When the HOLD function is executed again with the collection of current values being stopped temporarily the collection of current values restarts.

## 6.2 DISABLE COILS

The coil instruction can be forcibly fixed to ON, the energized condition (Disable ON), and to OFF, the de-energized condition (Disable OFF).

### 6.2.1 Display

The display of Disable ON/OFF coil is as follows.

#### ■ Coil

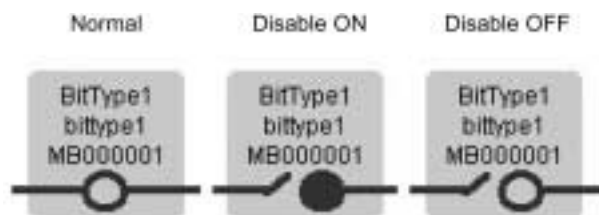

#### ■ Set Coil

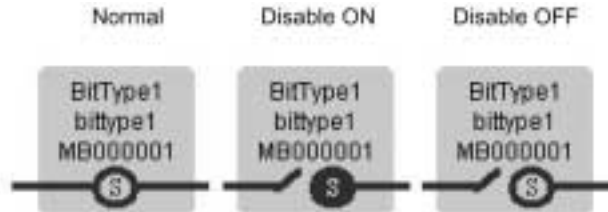

#### ■ Reset Coil

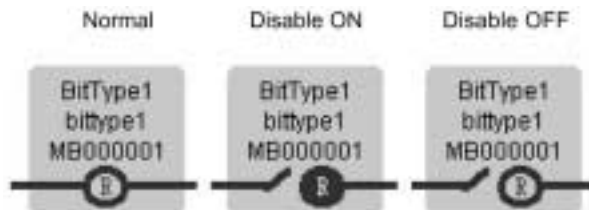

## 6.2.2 Set Disable ON

Set the coil instruction to forcibly fix to the ON status during the execution of a program.

1. Move the cursor to the coil instruction to be set to Disable ON. Select **Debug (D) - Force On (O)** of the menu.



2. The coil is expressed as being under the Disable ON status.

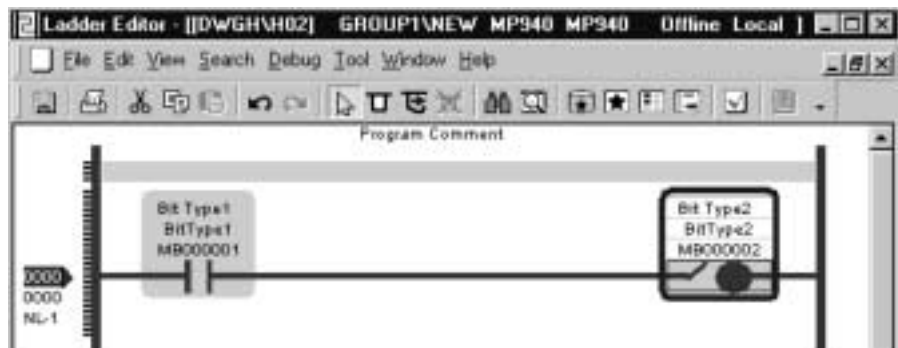

## 6.2.3 Set Disable OFF

Set the coil instruction to forcibly fix to the OFF status during the execution of a program.

1. Move the cursor to the coil instruction to be set to Disable ON. Select **Debug (D) - Force Off (F)** of the menu.



- 2. The coil is expressed as being under the Disable OFF status.

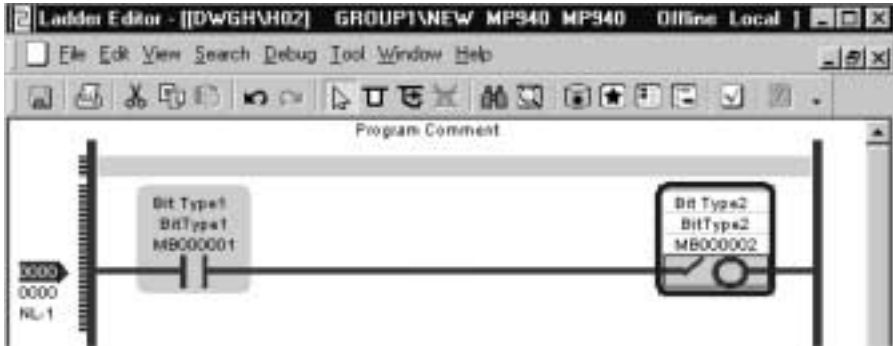

### 6.2.4 Cancel Disable

Cancel the Disable setting of the coil instruction.

- 1. Move the cursor to the coil instruction to cancel the Disable. Select **Debug (D) - Remove Force (V)** of the menu.



6

- 2. The coil is turned to normal condition.

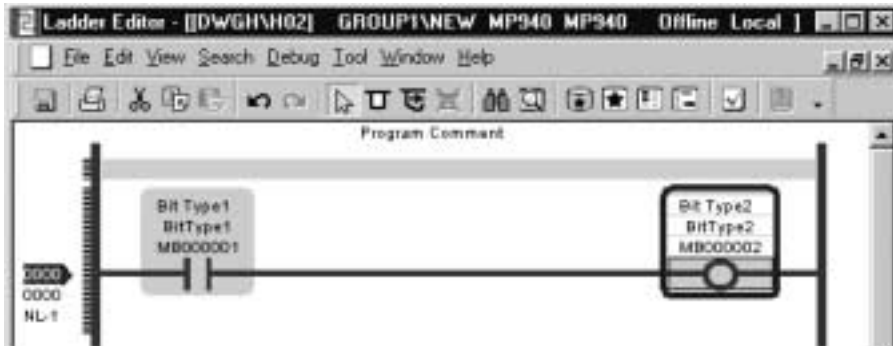

## 6.3 REFER

When the REFER function is executed with the cursor being at a SEE instruction or a user function name, jumping is performed to a DWG program or user function program screen in the on-line mode. The current values at the time at which the SEE instruction or the user function referencing FSTART instruction was executed can thus be displayed.

### 6.3.1 Refer on the SEE Instruction

1. Open the program in the on-line mode.
2. Move the cursor to the SEE instruction and select **Debug (D) - REFER (R)** of the menu.



3. The specified program is opened. In the sample shown above, the program screen for H01 is displayed.

### 6.3.2 Refer on the FUNC Instruction

1. Open the program in the on-line mode.
2. Move the cursor to the FUNC instruction and select **Debug (D) - REFER (R)** of the menu.

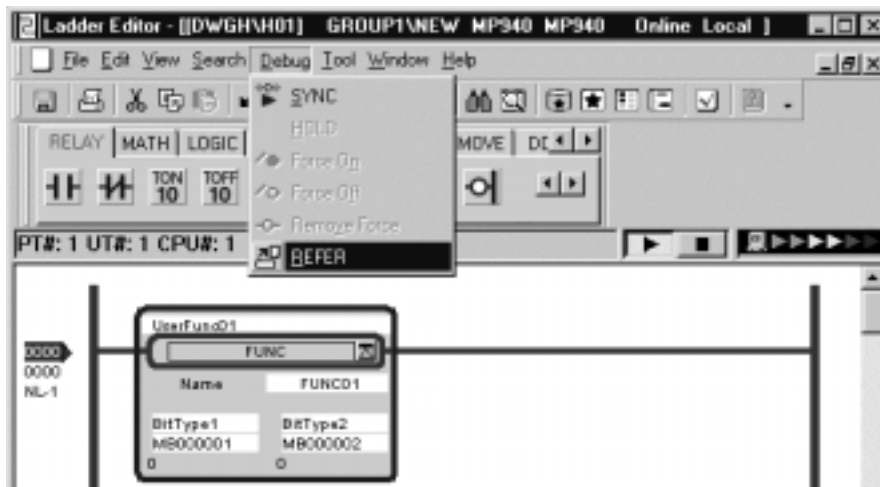

3. The specified user function program is opened. In the sample shown above, the user function program screen for FUNC01 is displayed

## 6.4 QUICK REFERENCE

Quick reference is a function to monitor the data used in the program. It is composed of the register list tab and the watch page tab. These tabs can be added and removed.

### 6.4.1 Display

The quick reference window is displayed.

1. Select **View (V) - Quick Reference (Q)** from the menu.
2. The quick reference window is displayed under the ladder window.

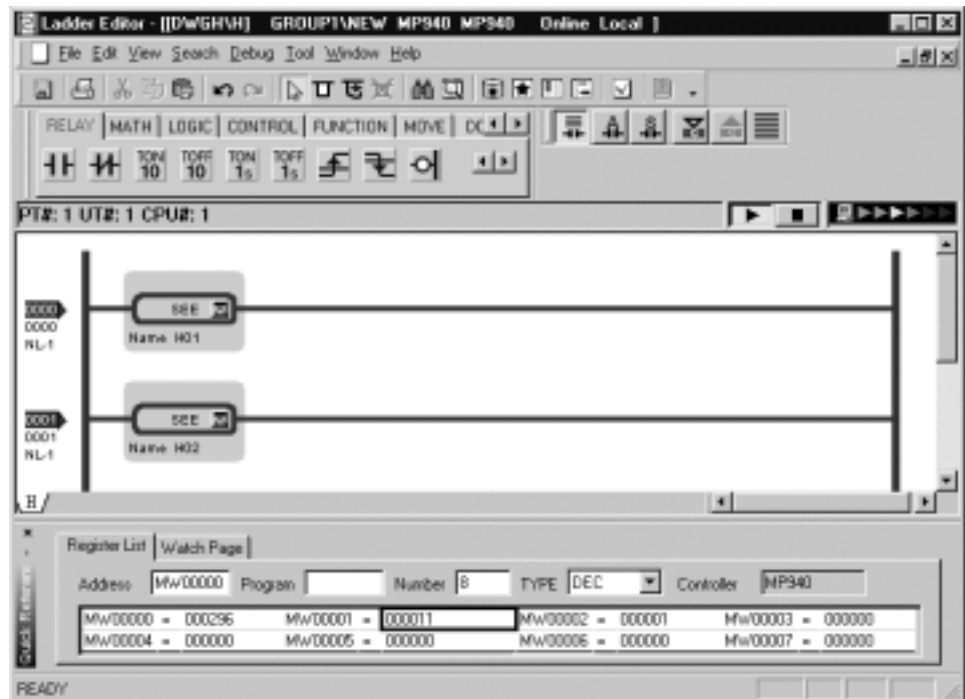



## 6.4.2 Register List Page

The data in the registers is displayed.

### ■ Register List Page Configuration

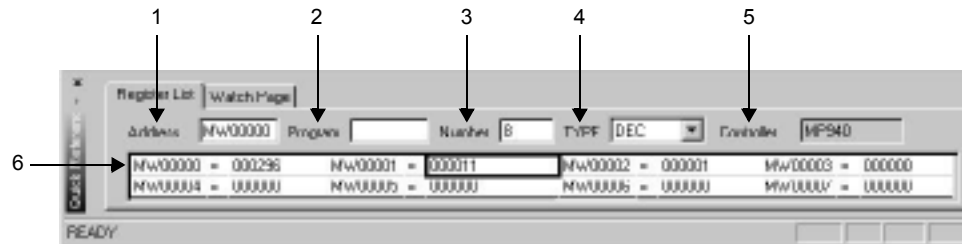

#### 1. Address

Input the register address of data.

A-registers and #-registers are not available.

#### 2. Program name

Input the program name. This is required only when a local register is specified in the address item.

#### 3. Number

Input the number of registers to be displayed.

Data Type	Minimum number
DEC	8
HEX	8
BIN	8
FLOAT	8
LONG	8
ASCII	2
ON/OFF	8

#### 4. TYPE

Select the data type.

Data Type	Register type	Display size	Display data
DEC	WORD (W)	1 Word	Decimal
HEX	WORD (W)	1 Word	Hexadecimal
BIN	WORD (W)	1 Word	Binary
FLOAT	FLOAT (F)	2 Word	Float
LONG	LONG (L)	2 Word	Decimal
ASCII	WORD (W)	1 Word	ASCII
ON/OFF	BIT (B)	1 Bit	ON = 1 OFF = 0

## 5. Controller

The controller's model name is displayed.

## 6. Current Values

The current values of the specified registers are displayed. They can be modified except the C-registers.

## ■ Register List Page Control

1. Right-click on the register list tab.
2. The pop-up menu is displayed

### View (V)

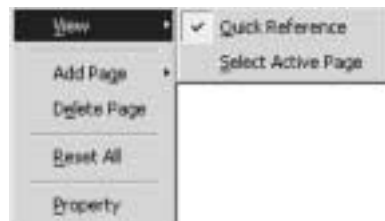

- Quick Reference  
Select **Quick reference (Q)**, the quick reference window is closed.
- Select Active Page  
Select **Select Active Page(S)**, the display page select dialog box is displayed.  
Set the page displayed in a quick reference window.  
All pages cannot be closed.



## ADD Page (G)

Add the displayed page.



### 1. Add list page

Select **Add List Page (A)**, a new list page is added.

### 2. Add watch page

Select **Add Watch Page (W)**, a new watch page is added.

### 3. Add graph page

Supported in the future.

## Delete Page (E)

Delete the displayed page.

## Reset All (R)

Reset the page configuration and all page data.

## Property (P)

The properties dialog box is displayed.

Input the title of the page.

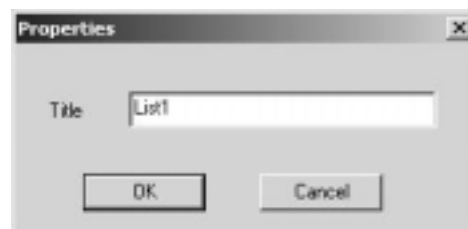

## 6.4.3 Watch Page

The specified data is displayed.

### ■ Watch Page Configuration

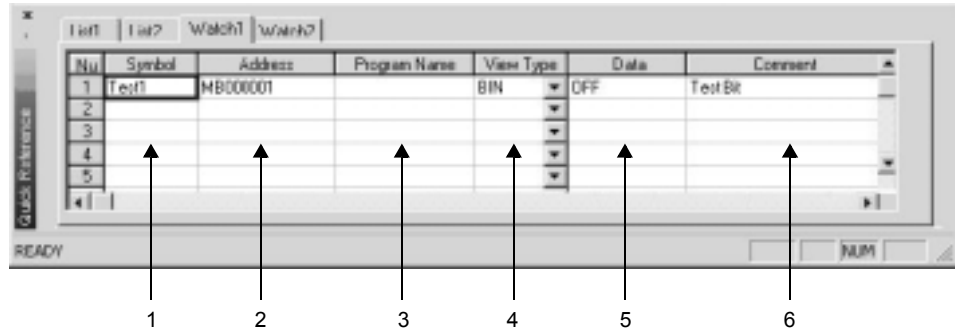

#### 1. Symbol

Input the symbol of data.

#### 2. Address

Input the register address of data.

A-registers and #-registers are not available.

#### 3. Program name

Input the program name. This is required only when a local register is specified in the address item.

#### 4. View Type

Select the view type of data.

Address display Type	View Type	Display data
Word (W)	DEC	Decimal
	BIN	Binary
	HEX	Hexadecimal
Long (L)	LONG	Decimal
	HEX	Hexadecimal
Float (F)	FLOAT	Float
Bit	BIN	ON(1), OFF (0)

#### 5. Data

The current values of the specified data are displayed. They can be modified except the C-registers.

#### 6. Comment

The comment of the symbol is displayed. When the comment of the symbol is edited, the symbol database is also updated.

## ■ Watch Page Control

1. Right-click on the right side of the watch page tab.
2. The pop-up menu is displayed.

Please refer to the paragraph on the register list page for the same menu as the register list page. Any menu items that are different from the register list page are explained here.

### Add (A)

1. Select Add (A) of the menu.
2. The registration address setting dialog box is displayed.

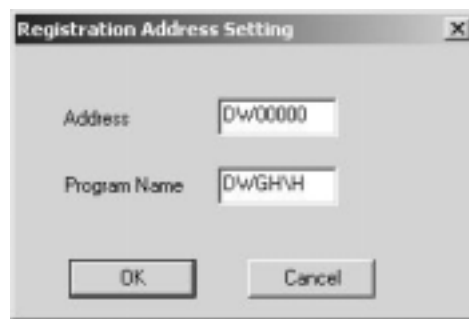

- Address  
Input the address of the specified data.
- Program name  
Input the program name.  
This is required only when a local register is specified in address item.

### Delete (D)

Delete the defined data at the cursor position. The deleted line becomes blank.

### Delete All Data (L)

Delete all defined data.

## Edit Page (P)



- Cut Page (T)  
Select **Cut Page (T)**, the specified page is cut and placed on the clipboard.
- Copy Page (C)  
Select **Copy Page (C)**, the specified page is copied on the clipboard.
- Paste Page (P)  
Select **Paste Page (P)**, the page on the clipboard is added as a new page.

### 6.4.4 The definition data is added from the ladder editor.

The definition data can be added from the ladder program screen.

1. Select the symbol or address of instruction in a ladder program.
2. Select *Edit (E) - Add address to quick reference (Q)* of the menu or right-click and select *Add address to quick reference (Q)* from the menu.
3. The specified data is added to the active watch page.

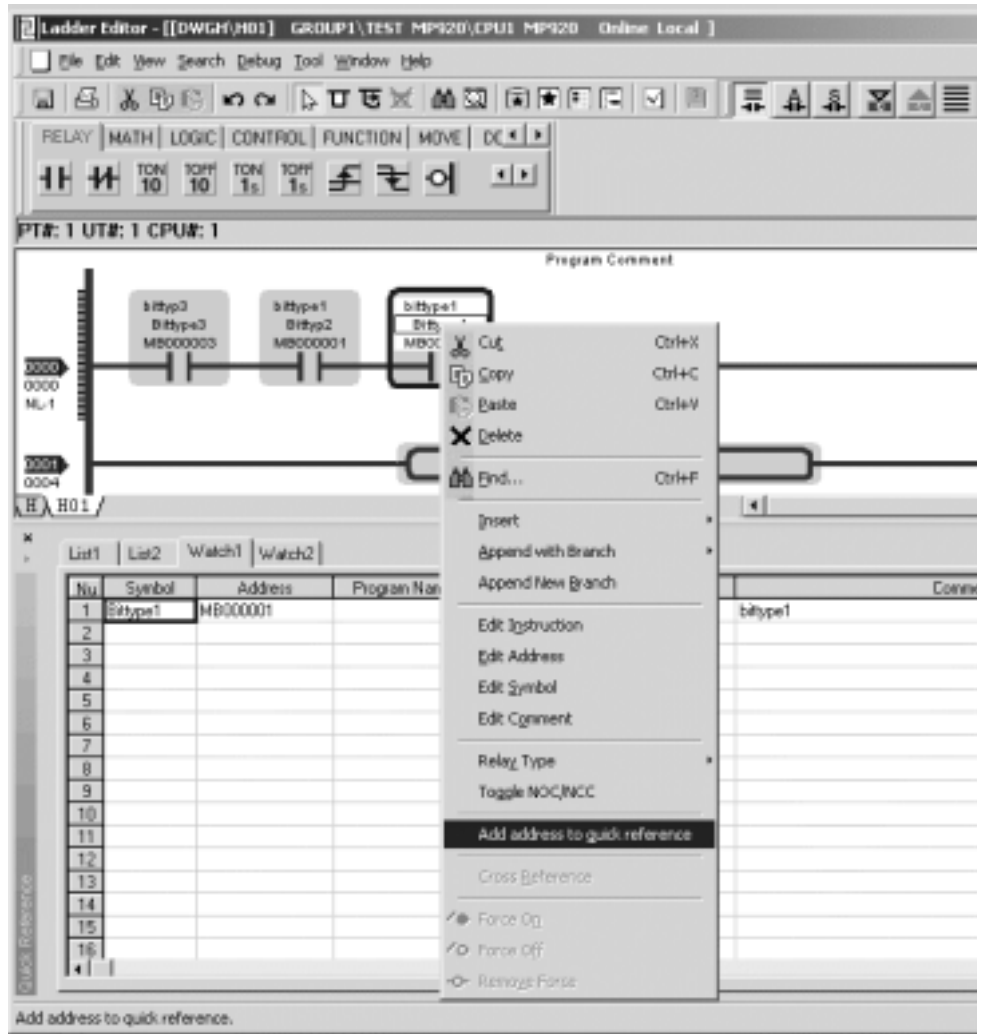

The menu is disabled during the following conditions.

- Neither Symbol nor Address of data is selected.
- The selected symbol data is not effective.
- The selected address data is not effective.

## 6.5 CURRENT VALUE MONITOR

The current value monitor is a function to display an internal state of the symbol or register used in the instruction at the cursor position in the program. It is mainly used to monitor current value not normally displayed on the program screen such as EXPRESSION/IF/WHILE instruction. It can display the current value in the selected data type such as decimal, hexadecimal, and binary.

### 6.5.1 Display of Current Value Monitor Window

1. Select *View (V) - Current Value Monitor (R)* from the menu.



This is available only in the on-line mode.

---

2. The current value monitor window is displayed under the ladder window.



There are two kinds of display formats.

---



## ■ Display in the Enhanced format for EXPRESSION, IF, and WHILE instruction

It is a format for EXPRESSION, IF, and WHILE instructions. The operational expression or the conditional expression is displayed with the current value.

1. Select **Display All (A)** from the pop-up menu when the cursor position in the program is on EXPRESSION, IF, or WHILE instruction.
2. This display format is selected.

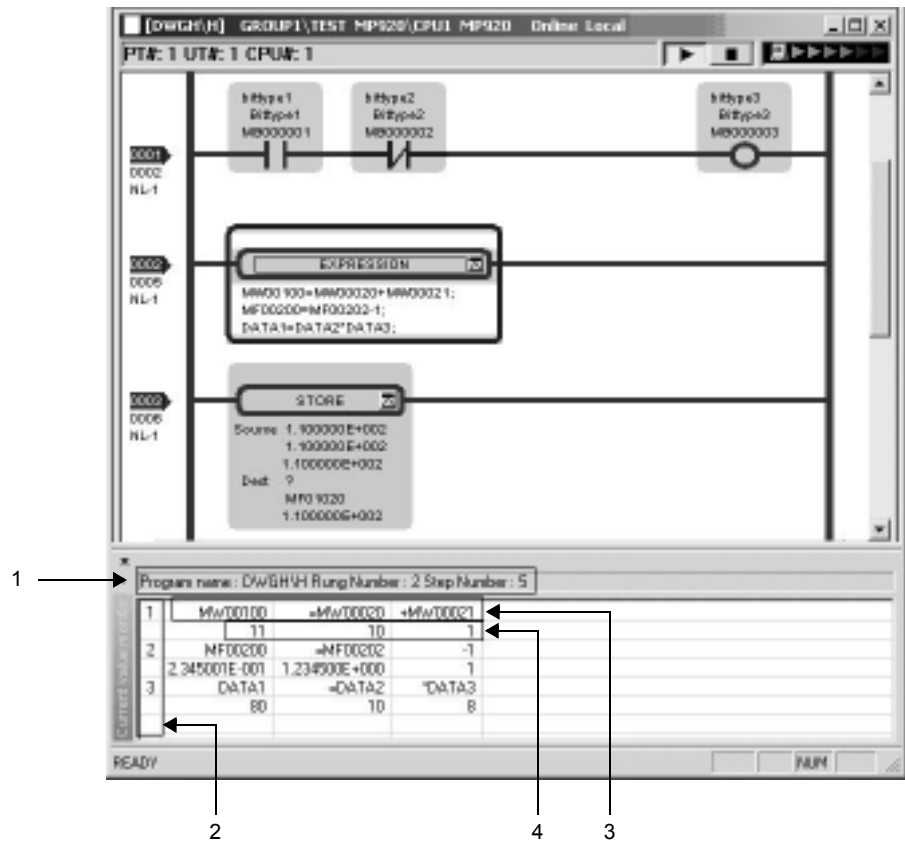

1. Information at the cursor position

The program name, the rung number, and the step number at the cursor position are displayed.

2. Line number

The line number of the operational expression or conditional expression is displayed.

3. Operational expression

The operational expression or conditional expression is displayed.

4. Current value

The current value of the operational expression or conditional expression is displayed.

## ■ Display in the Standard Format

It is a format to display all instructions. The operand of instruction and the current value are displayed.

Select **Display Normal (N)** of the pop-up menu when the cursor position in the program is on EXPRESSION, IF, or WHILE instruction.

This display format is selected.



1. The current value of the left side of the operational expression is displayed when the cursor position is on the EXPRESSION instruction.
2. The logical state of the conditional expression that is true or false is displayed when the cursor position is on IF or WHILE instruction.

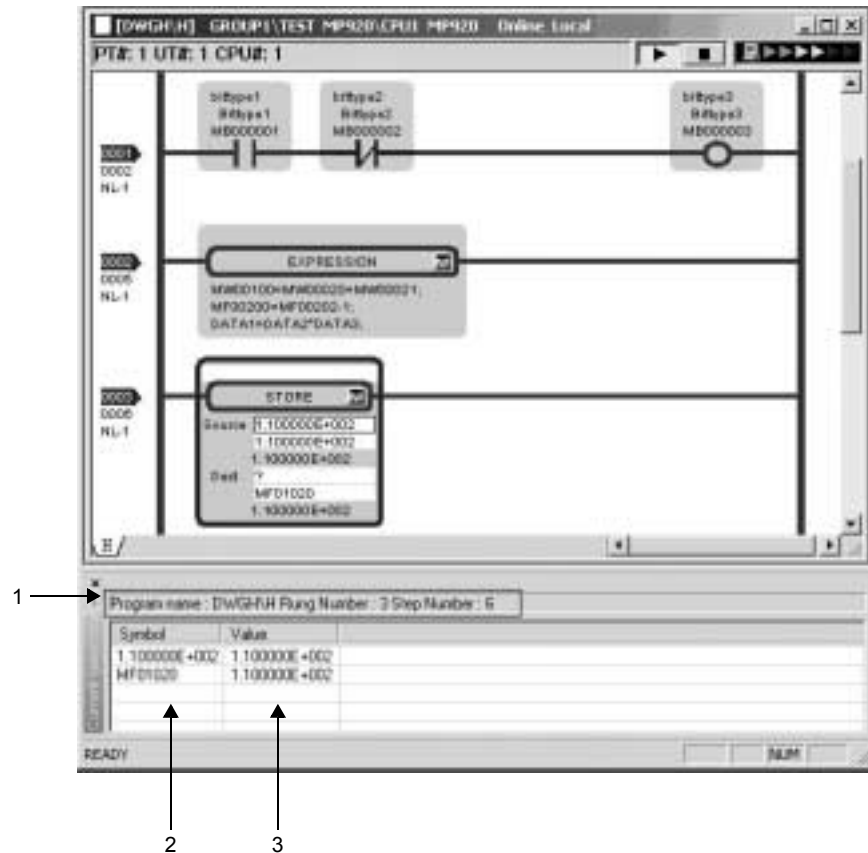

1. Information at cursor position

The program name, the rung number, and the step number at the cursor position are displayed.

2. Symbol

The symbol or the address of the operand is displayed.

3. Value

The current value of the operand is displayed.

## 6.5.2 Start and Stop Current Value Monitor

The current value monitor is refreshed simultaneously with the current value display in the program. The current value monitor can't display the current value when the current value of display in the program stops. Moreover, it can't display it in the case as follows.

- When an instruction at the cursor position is not executed by a programmed control instruction which IF and is WHILE, etc.
- When the cursor position is outside the program screen by a scroll operation and etc.

Display when current value monitor is executed

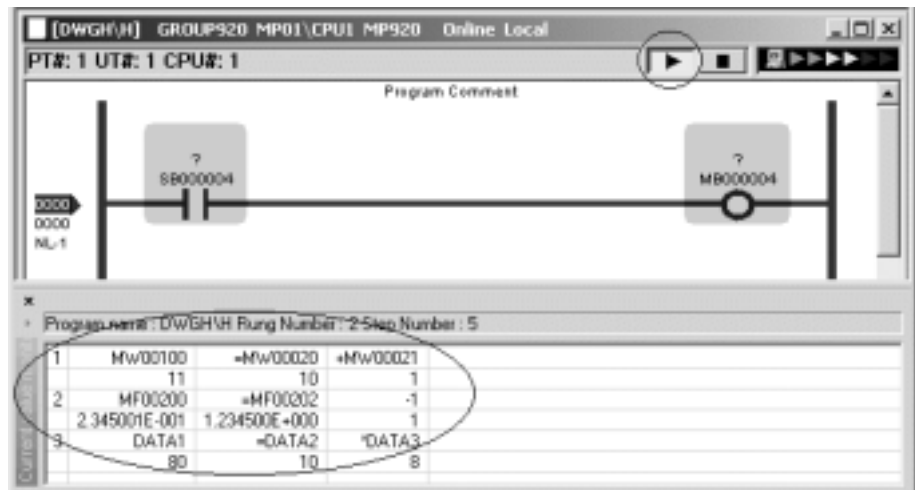

The current value is displayed.

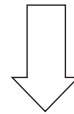

Display when current value monitor stops

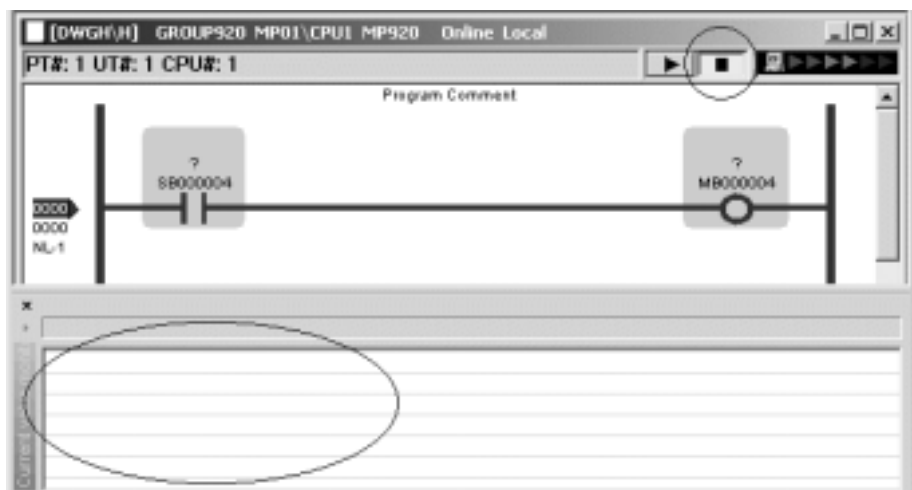

The current value is not displayed.

### 6.5.3 Pop-up Menu

1. Select **Shift + F10**.
2. The pop-up menu is displayed.

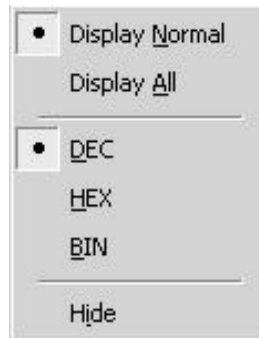

#### ■ Display Normal (N)

The current value monitor in the standard format is displayed. The meaning of symbol and value item is different according to an instruction at the cursor position.

#### EXPRESSION instruction

The current value of the left side of the operational expression is displayed.

Symbol	Value
MW00100	100
DATA1	200
MF00200	1.234567E + 001

#### IF and WHILE instruction

The current execution result of the conditional expression is displayed.

Symbol	Value
IF instruction	True or False

Symbol	Value
WHILE instruction	ON or OFF

#### Other instructions

The current value of the operand of the instruction is displayed.

Symbol	Value
MW00101	100
DATA2	200

### ■ Display All (A)

This is available only when the cursor position is on an EXPRESSION, IF, or WHILE instruction. The operational expression or conditional expression is displayed with the current value.

### DEC (D)

All current values are displayed as a decimal number.

### HEX (H)

All current values are displayed as a hexadecimal number.

### BIN (B)

All current values are displayed as a binary number.

### Hide (I)

The current value monitor window is closed.

---

## PRINTING

The printing of the ladder program is explained. It is executed for a active program in the program window.

7.1 PRINT PREVIEW	-----7-2
7.2 PRINTING	-----7-5
7.3 PAGE SETUP	-----7-7

## 7.1 PRINT PREVIEW

The print image of the specified program is displayed in the print preview window.

1. Select **File (F) - Print Preview (V)** of the menu.

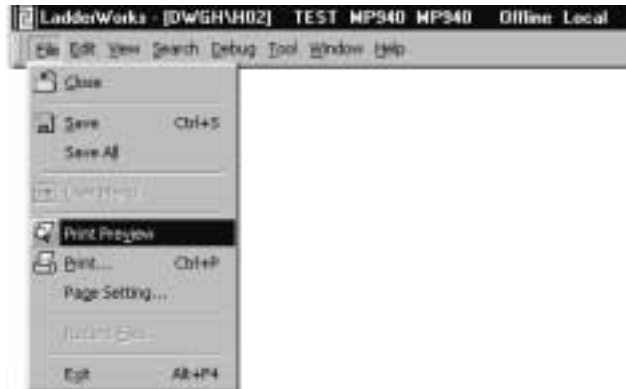

2. The print preview window is displayed.



---

As for a print preview, the printing image of the whole program is always displayed.  
The printing image corresponding to the [Print range] of a print dialog is not displayed.

---

## ■ Print Preview

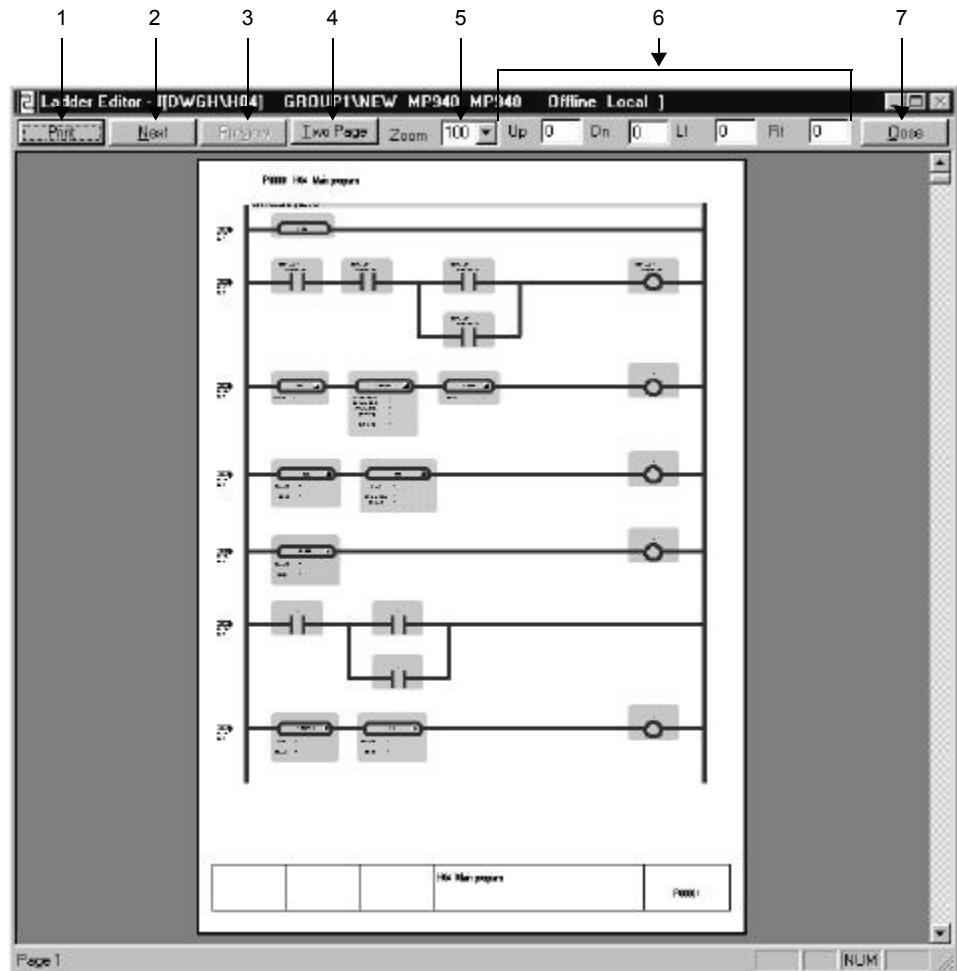

### 1. Print

The print preview window is closed and the "Print" dialog box is displayed. Refer to 7.2 Printing about the details.

### 2. Next

The next page is displayed. It is disabled when there are no more pages.

### 3. Previous

The previous page is displayed. It is disabled when the first page is displayed.

### 4. Two Page

Select the "Two Page" button and two pages are sideways arranged and then the button display is changed to the "One Page". Select the "One Page" button and the display is returned and then the button display is changed to the "Two Page".



5. Zoom

The screen size expanding reduces the displays of the instruction and the text, etc. as they are. The scale can be selected from the drop down list box. The scale is switched by five stages (200%, 150%, 100%, 75%, and 50%). An arbitrary scale value cannot be input. The rung is expressed to be turned in the program window when the width of rung cannot finish be settled by the selected scale.

6. Up/Dn/Lf/Rt

The margins of the left/right side and the upper/lower are set.

7. Close

Close the print preview window and return to the program window.

< Key Operation >: Esc

## 7.2 PRINTING

The program and selected part program in active status are printed.

1. Select **File (F) - Print (P)** of the menu.



< Key Operation >: Ctrl + P

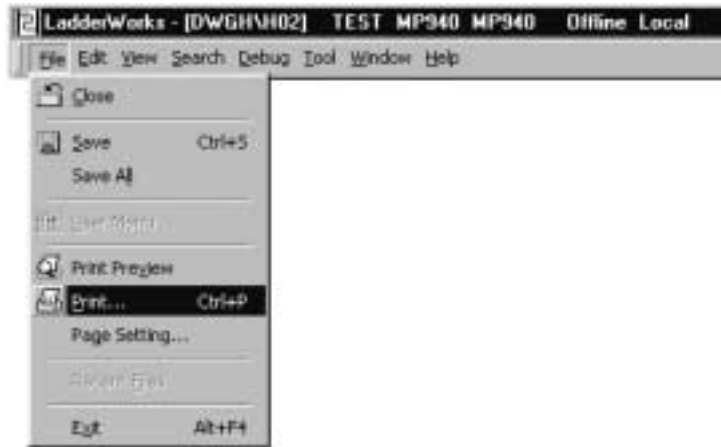

2. The dialog box is displayed
3. Select the OK button after setting the required data. The printing is executed.

### ■ Print Dialog

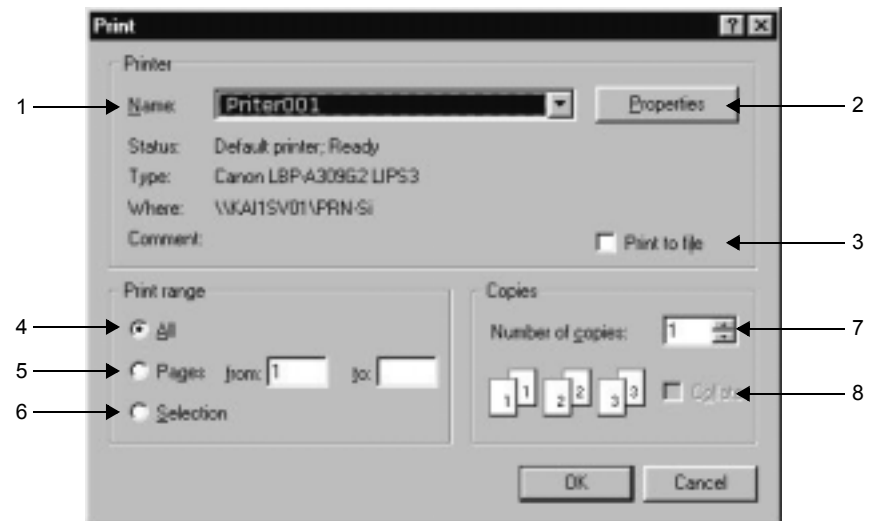

## Printer

1. Name

Select the printer available.

2. Properties

The property window of the specified printer is displayed.

3. Print to file

Print to file when checked.

## Print range

4. All

Print all pages.

5. Pages

Set the printed range by the page number.

6. Selection

It is available when the rung, the rung comment, or program comment is selected in the program. Only the selected objects can be printed.

## Copies

7. Number of copies

Set the number of copies.

8. Collate (Disabled)

---

<b>IMPORTANT</b>
------------------

When it is hard to see the character of a printing result, set printing quality as high resolution with the property of a printer.

---

## 7.3 PAGE SETUP

The margins, a size of the form, and page layout of the printer are set for an active ladder program.

1. Select **File (F) - Print Setting (G)** of the menu.

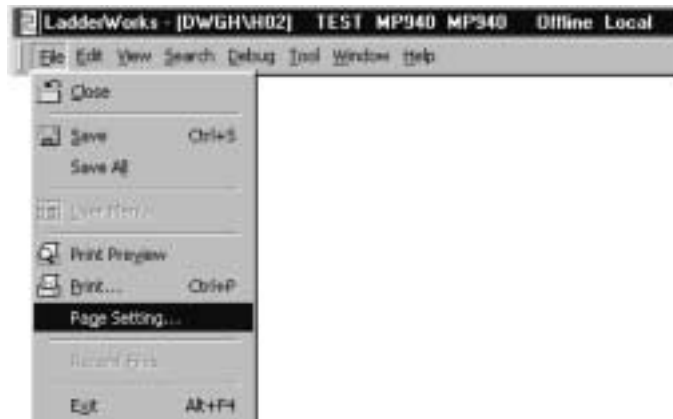

2. The dialog box is displayed.

### ■ Page Setup Dialog

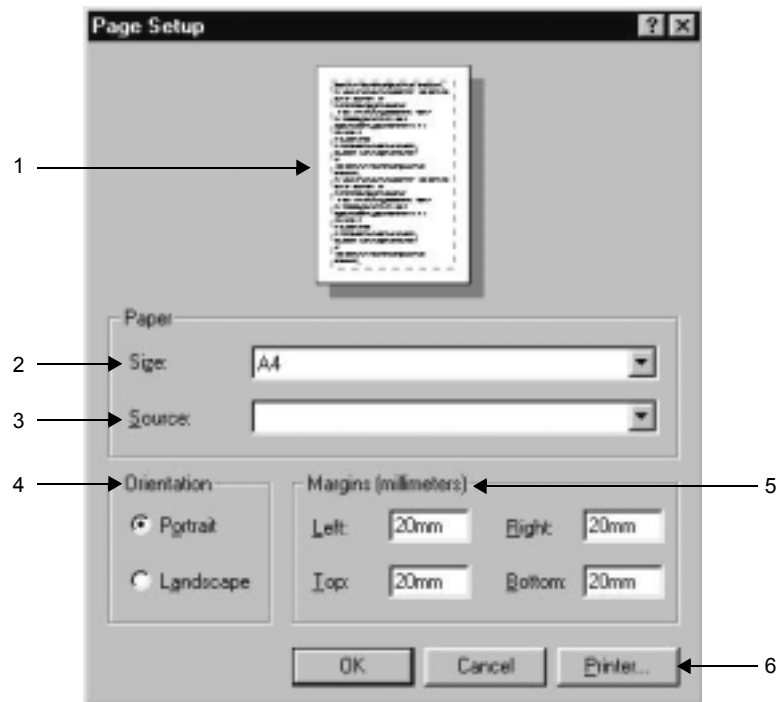

1. Image of Printing Page

The image of the printed page is displayed. Its orientation is changed to the specified setting. The margins are displayed as the dotted line in it.

## Paper

### 2. Size

Select the size of the paper.

### 3. Source

Select the method of paper feed.

### 4. Orientation

Select the orientation of printing.

### 5. Margins

The margins of the left/right side and the upper/lower are set.

### 6. Printer

Select the used printer. The dialog box is displayed when selecting this button.

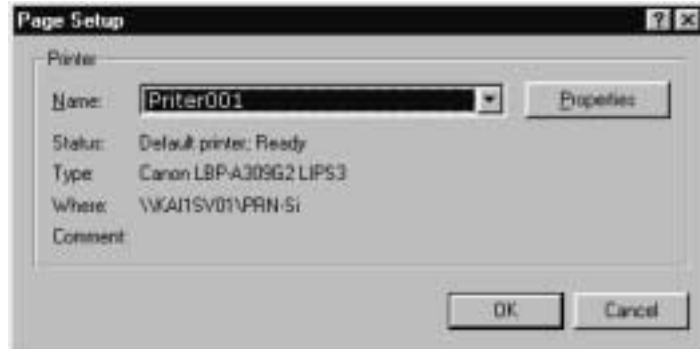

A set peculiarity to the printer model is displayed when selecting the properties button in the dialog. For the setting to the printer, refer to its manual about the details.

---

---

## LADDER CONVERSION TOOL

The ladder conversion tool is a tool which converts a ladder program file made in the original ladder editor (MotionWorks Ver.3.XX or earlier) into a ladder program file for the new ladder editor (MotionWorks Ver 4.XX or greater). It can convert the program files, definition files, and some data files to new ones.

8.1 START LADDER CONVERSION TOOL	-----8-2
8.2 LADDER CONVERSION TOOL	-----8-3
8.3 MENU	-----8-7

## 8.1 START LADDER CONVERSION TOOL

Start the ladder conversion tool from the file manager.

1. Move the cursor to the PLC folder shown with × mark that shows it was made in the original ladder editor.
2. Select **Tool (T) - Ladder Converter Tool (L)**.

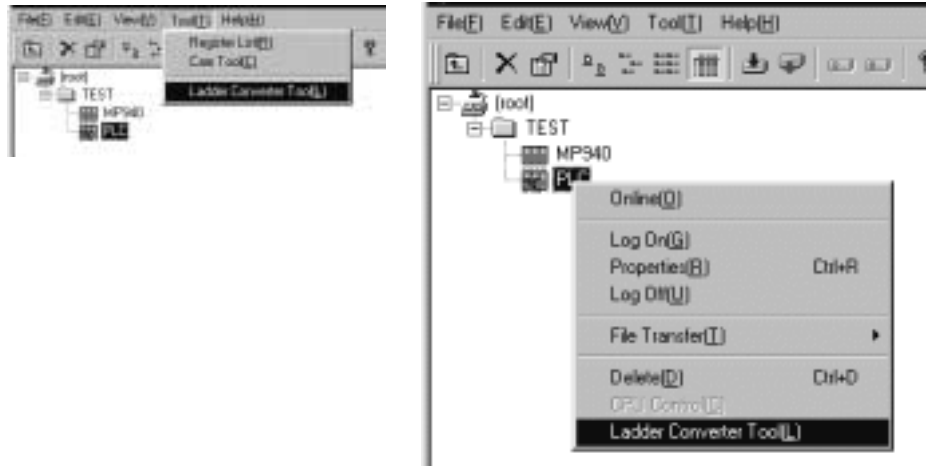

3. The ladder conversion tool is displayed.



1. The ladder conversion tool is displayed by right-click menu or pop-up menu.
2. The menu for the ladder conversion tool is not displayed when the cursor is not on a PLC folder that was made in the original ladder editor.

## 8.2 LADDER CONVERSION TOOL



### ■ Main Window

Set the ladder conversion conditions.

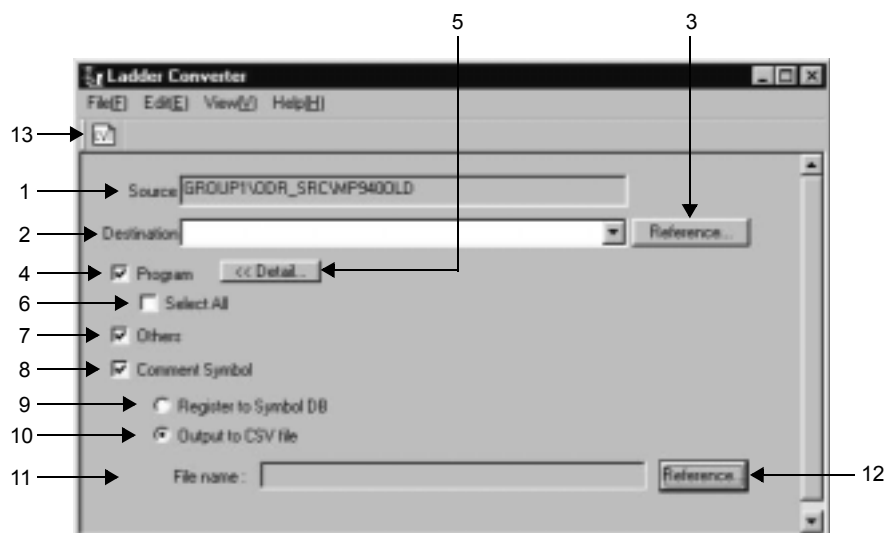



### 1. Source

The PLC folder where the ladder conversion tool is started is displayed as a source PLC folder. It can't be changed.

### 2. Destination

Set the destination PLC folder where the converted program is stored. If there is no specified PLC folder, it is automatically created.

### 3. Reference

Select the destination PLC folder from among the existing PLC folders. This is the Browse function.

- a) Click **Reference** button.
- b) The Select dialog box is displayed.
- c) Move to the cursor on the specified PLC folder.
- d) Click **OK** button.
- e) The selected PLC folder is input as the destination PLC folder.

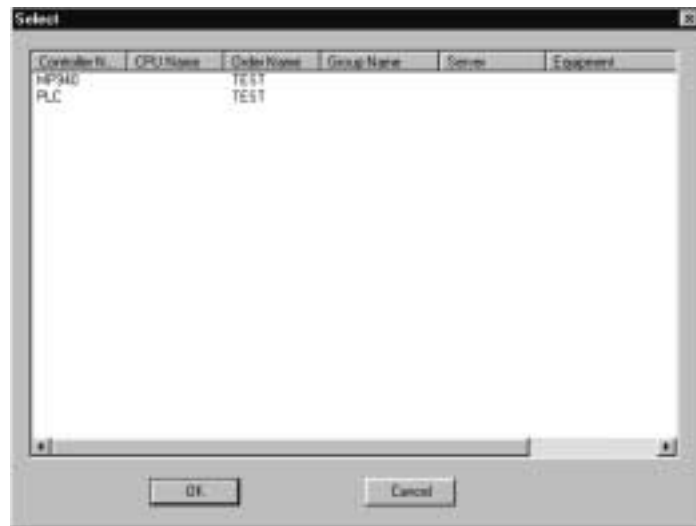

### 4. Program

Only the program is converted.

### 5. Detail

Click Detail button, and the detail window is displayed.

The individual program can be selected in the detail window. It is described later.

It is available when program check box is set.

### 6. Select All

All programs in the PLC folder are converted.

It is available when program check box is set.

### 7. Others

The definition files and other data files except programs are converted.

#### 8. Comment Symbol

The Comment Symbols in the source PLC folder are converted to the format of Symbol Database in the destination PLC folder .

#### 9. Register to Symbol DB.

After the Comment Symbols is converted, they are registered to the Symbol Database in the destination PLC folder.

#### 10. Output to CSV file

The Comment Symbols in the source PLC folder are output to the CSV file which can be importing the Symbol Database in the destination PLC folder.

#### 11. File name

The output file name of the CSV file is set. The destination folder is selected with the Reference button.

#### 12. Reference button at CSV file name

The destination of the CSV file is selected.

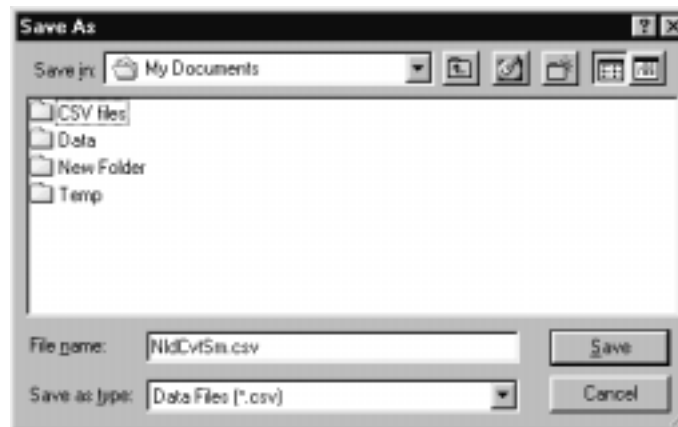

#### 13. Execute Icon

Click the execute icon.

The ladder conversion process is executed.

## ■ Output Window

The conversion results are displayed.

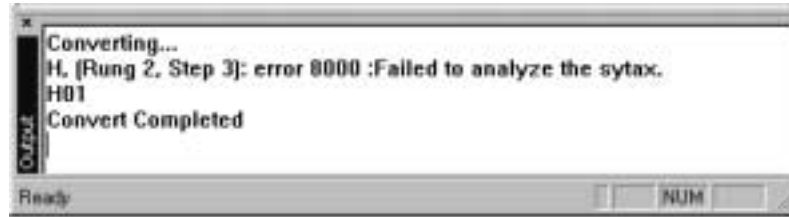

The ladder conversion is executed for each program file, and the conversion result is output to the output window one by one.

When a conversion error is detected while converting the ladder, the following error messages are output.

- Program name in the source PLC folder
- Step number in the program in the source PLC folder
- Rung number in the program in the destination PLC folder
- Error code
- Error Message

When a conversion error is none, only the Program name in the source PLC folder is output.

Move to the location in the program where the error is detected as follows.

1. Move the cursor on to the specified error message in the output window.
2. Double-click or push ENTER key.
3. Jump to the selected location in the specified program by Edit menu.

## ■ Detail Window

A detail window is displayed in the docked mode by clicking Detail button in the main window. The programs in the program folder are arranged using the tab.

Set the check box of individual program or Select All.

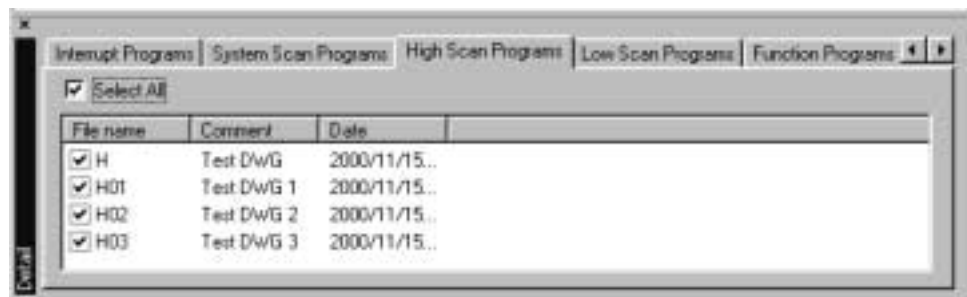

## 8.3 MENU

### ■ File (F)



1. Convert Execute (O)  
Execute the ladder conversion process.
2. Export Log (E)  
The conversion log in the output window is exported to Text file.
3. Exit (X)  
Exit the ladder conversion tool.

### ■ Edit (E)



1. Refer Destination Program (D)  
The program in the destination PLC folder is selected when referring to the program from the conversion result message in the output window.
2. Refer Source Program (S)  
The program in the source PLC folder is selected when referring to the program from the conversion result message in the output window.

## ■ View (V)



### 1. Tool Bar (T)

The tool bar is displayed.

### 2. Status Bar (S)

The status bar is displayed.

### 3. Output (O)

The output window is displayed.

### 4. Change Focus (F)

The focus is changed between Main window and Output window, etc.

## ■ Help (H)

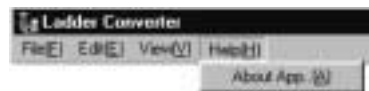

### • About App.. (A)

The version information is displayed.

# Appendix A

---





A

A.1 MENU -----A-2













## A.1 MENU

The menu displayed in the program window is explained as follows. The menu is changed according to the selected operation environment. Details are explained in each paragraph.

### ■ File

Menu	Shortcut Key	Function
File (F)		
 Close (C)		Close the active document.
 Save (S)	Ctrl + S	Save the document.
 Save All (L)		Save all opened files.
 Print Preview (V)		Display full pages.
 Print... (P)	Ctrl + P	Print the active document.
Page Setting... (G)		Change the page printing options.
Exit (X)	Alt + F4	Quit the application; prompts to save documents.













## ■ Edit

	Menu	Shortcut Key	Function
	Edit (E)		
	Undo (U)	Ctrl + Z	Undo the last action.
	Redo (R)	Ctrl + Y	Redo the previously undone action.
	Cut (T)	Ctrl + X	Cut the selection and put it on the Clipboard.
	Copy (C)	Ctrl + C	Copy the selection and put it on the Clipboard.
	Paste (P)	Ctrl + V	Insert Clipboard contents.
	Delete (D)	Delete	Delete the object at cursor.
	Insert Rung (I)	Insert	Insert a new empty rung above current rung.
	Add Rung (A)	-	Add new empty rung below current rung.
	Insert Rung Comment (U)	-	Insert a rung comment at the cursor.
	Insert (I)	Insert	Insert the instruction on the cursor position.
	Add with Branch (A)	Ctrl + Insert	Insert the instruction with the branch on the cursor position.
	Insert New Branch (B)	Ctrl + B	Insert the new branch at the cursor.
	Add New Branch (B)	-	Add new branch at the cursor.
	Normal Edit Mode (N)	Ctrl + U	Edit in the normal edit mode
	Branch Create Mode (B)	Ctrl + I	Create the new branch.
	Branch Edit Mode (E)	Ctrl + E	Edit the branch.
	Edit Program Comment (G)	-	Edit the program comment.
	Edit Rung Comment (E)	-	Edit the rung comment.
	Edit Instruction (N)	-	Edit the instruction.
	Edit Comment (O)	-	Edit the comment of the instruction.
	Edit Symbol (S)	-	Edit the symbol of the instruction.
	Edit Address (E)	-	Edit the address of the instruction.
	Edit Conditional Expression (E)	-	Edit the conditional expression of the instruction.
	Edit Operational Expression (E)	-	Edit the operational expression of the instruction.
	Edit String (E)	-	Edit the string of the instruction.
	Edit User Function (E)	-	Edit the name of the specified user function.
	Relay Type (Y)	-	Change the type of relay.
	Automatic address Allocation (T)	Ctrl + R	Execute automatic address allocation.
	Add address to quick reference (Q)	-	Add address to quick reference.
	Select All (L)	Ctrl + A	Select all objects.
	Verify File (V)	F8	Verify the specified program file.
	Verify All Program Files (F)	-	Verify all program files.







A



## ■ View/Search/Debug

Menu	Shortcut Key	Function
<b>View (V)</b>		
Tool Bar (T)		Change the display/non-display of the tool bar.
Standard (S)		
Customize (C)		
Status Bar (S)		Change the display/non-display of the status bar.
Quick Reference (Q)		Change the display/non-display of the quick reference window.
Output (O)		Change the display/non-display of the output window.
Instruction Palette (I)		Change the display/non-display of the instruction palette.
Quick View Properties (V)		Change the display/non-display of the quick view property.
Cross Reference Data (F)		Change the display/non-display of the Cross Reference Data.
Function Bar (N)		Change the display/non-display of the Function Bar.
Current Value Monitor (R)		Change the display/non-display of the Current Value Monitor.
 Comment/Symbol/Address (C)		Change the display/non-display of the comment/address/symbol of the instruction.
 Comment/Address (A)		Display comment and address of the instruction.
 Comment/Symbol (Y)		Display comment and symbol of the instruction.
 Comment Up (U)		Increase the display line of the comment of the instruction.
 Comment Down (D)		Decrease the display line of the comment of the instruction.
 Zoom... (Z)		Display the zoom setting window.
 Editor Options... (E)	Alt + Enter	Display the editor options setting window.
<b>Search (S)</b>		
 Find... (F)	Ctrl + F	Find the specified character string.
Replace... (P)	Ctrl + H	Replace the specified character string with other string.
Find from File... (I)		Find the specified character string in the plural program files.
Cross Reference (R)		Execute the cross-reference function.
<b>Debug (D)</b>		
 SYNC (S)		Get the current values of a program at the time.
 Force On (N)		Set the coil instruction to forcibly fix to the ON status during the execution of a program.
 Force Off (F)		Set the coil instruction to forcibly fix to the OFF status during the execution of a program.
 Remove Force (V)		Cancel the Disable setting of the coil instruction.
 REFER (R)		Open the referred program or user function.

## ■ Tool/Window/Help

Menu	Shortcut Key	Function
<b>Tool (T)</b>		
Symbol System (S)		Set the data of the symbol system.
 Symbol Manager (S)		Start the symbol manager.
 Symbol List (L)		Display the symbol list.
 Register Map (R)		Display the register map.
 Unregistered Symbol List (N)		Display the unregistered symbol list.
Customize User Tab... (C)		Customize the instruction palette.
 File Manager		Start the File Manager.
 Print Manager		Start the Print Manager.
<b>Window (W)</b>		
Close (C)	Ctrl + F4	Close the active window.
Close All (L)		Close all windows.
Cascade (D)		Display the currently opened windows one over the other.
Tile Horizontally (H)		Display the currently opened windows one by one horizontally.
Tile Vertically (V)		Display the currently opened windows one by one vertically.
Change Focus (F)	Ctrl + F7	Change the focus of the active window.
Next (X)	Ctrl + F6	Change the active program window.
<b>Help (H)</b>		
Ladder Works Help (H)	F1	Display the index of the on-line documents.
Version Information (V)		Display the version number and so on.

A

■ Cascade Menu for Inserting and Appending Instruction

Category		Mnemonic Key		Full Name
0	RELAY	0	NOC	Normally Opened Contact
		1	NCC	Normally Closed Contact
		2	TON[10ms]	On-delay timer (10 ms)
		3	TOF[10ms]	Off-delay timer (10 ms)
		4	TON[1s]	On-delay timer (1 sec)
		5	TOF[1s]	Off-delay timer (1 sec)
		6	ON-PLS	Rise Pulse
		7	OFF-PLS	Fall Pulse
		8	COIL	Coil
		9	S-COIL	Set Coil
		A	R-COIL	Reset Coil
1	MATH	0	STORE	Store
		1	ADD	Add
		2	ADDX	Expanded Add
		3	SUB	Subtract
		4	SUBX	Expanded Subtract
		5	MUL	Multiply
		6	DIV	Divide
		7	MOD	Integer Remainder
		8	REM	Real Remainder
		9	INC	Increment
		A	DEC	Decrement
		B	TMADD	Time Add
		C	TMSUB	Time Subtract
		D	SPEND	Time Spend
		E	INV	Inverse
		F	COM	Complement
		G	ABS	Absolute
		H	BIN	Convert to Binary
		I	BCD	Convert to BCD
		J	PARITY	Count ON Bit
K	ASCII	Convert Character to ASCII		
L	BINASC	Convert Binary to ASCII		
M	ASCBIN	Convert ASCII to Binary		

(cont'd)

Category		Mnemonic Key		Full Name
2	LOGIC	0	AND	AND
		1	OR	OR
		2	XOR	Exclusive OR
		3	<	Less Than
		4	<=	Less Than or Equal
		5	=	Equal
		6	!=	Not Equal
		7	>=	Greater Than or Equal
		8	>	Greater Than
		9	RCHK	Range Check
3	CONTROL	0	SEE	Call Program
		1	FUNC	User Function
		2	INS	Direct Input String
		3	OUTS	Direct Output String
		4	XCALL	Call Extended Program
		5	WHILE	While Do
		6	FOR	For
		7	IF	If then
		8	ELSE	Else
		9	END_WHILE	End of While
		A	END_FOR	End of For
		B	END_IF	End of IF
		C	EXPRESSION	Expression
4	FUNCTION	0	SQRT	Square Root
		1	SIN	Sine
		2	COS	Cosine
		3	TAN	Tangent
		4	ASIN	Arc Sine
		5	ACOS	Arc Cosine
		6	ATAN	Arc Tangent
		7	EXP	Exponential
		8	LN	Natural Logarithm
		9	LOG	Logarithm Base 10

A

(cont'd)

Category		Mnemonic Key		Full Name
5	MOVE	0	ROTL	Bit Rotate Left
		1	ROTR	Bit Rotate Right
		2	MOVB	Move Bit
		3	MOVW	Move Word
		4	XCHG	Exchange
		5	SETW	Set Word
		6	BEXTD	Extend Byte to Word
		7	BPRESS	Compress Word to Byte
		8	BSRCH	Binary Data Search
		9	SORT	Sort
		A	SHIFTL	Bit Shift Left
		B	SHIFTR	Bit Shift Right
		C	COPYW	Copy Word
		D	BSWAP	Byte Swap
6	DDC	0	DZA	Dead Zone A
		1	DZB	Dead Zone B
		2	LIMIT	Limit
		3	PI	PI Control
		4	PD	PD Control
		5	PID	PID Control
		6	LAG	First Order Lag
		7	LLAG	Phase Lead Lag
		8	FGN	Function Generator
		9	IFGN	Inverse Function Generator
		A	LAU	Linear Accelerator
		B	SLAU	S-Curve Linear Accelerator
		C	PWM	Pulse Width Modulation
7	TABLE	0	TBLBR	Table Block Read
		1	TBLBW	Table Block Write
		2	TBLSRL	Table Row Search
		3	TBLSRC	Table Column Search
		4	TBLCL	Table Block Clear
		5	TBLMV	Table Block Move
		6	QTBLR	Queue Table Read
		7	QTBLRI	Queue Table Read
		8	QTBLW	Queue Table Write
		9	QTBLWI	Queue Table Write
		A	QTBLCL	Queue Table Pointer Clear

(cont'd)

Category		Mnemonic Key		Full Name
8	SYSTEM	0	COUNTER	Counter
		1	FINFOUT	First-in First-out
		2	TRACE	Trace
		3	DTRC-RD	Data-Trace Read
		4	FTRC-RD	Failure Data-Trace Read
		5	ITRC-RD	Inverter-Trace Read
		6	MSG-SND	Message Send
		7	MSG-RCV	Message Receive
		8	ICNS-WR	Inverter Constant Write
		9	ICNS-RD	Inverter Constant Read
9	SFC	0	SFC	SFC Function
		1	ABOX	SFC Action Box
		2	SBOX	Sequence BOX
		3	SFCSTEP	Taking out System Step Number
A	MOTION	0	MSEE	Call Motion Program
		1	MSFC	Motion SFC Function

A

# Appendix B

---

B.1 MENU in SYMBOL MANAGER -----B-2

## B.1 MENU in SYMBOL MANAGER

The menu displayed in the symbol manager is explained as follows. The menu is changed according to the selected operation environment. Details are explained in each paragraph.

File (F)			
	Save (S)	Ctrl + S	Save the document.
	Import (I)	–	Convert the CSV format data to the name data at the cursor.
	Export (E)	–	Convert the name data to the CSV format file.
	Properties... (R)	Alt + Enter	Display the property window.
	Exit (X)	Alt + F4	Quit the application; prompts to save documents.
Edit (E)			
	Add (A)	–	Add new lines.
	Insert (I)	–	Insert new lines.
	Delete (D)	Delete	Delete the selected data.
	Automatic Address allocation (T)	Ctrl + R	Execute the Automatic Address allocation.
View (V)			
	Tool Bar (T)	–	Show or hide the toolbar and customize toolbars.
	Status Bar (S)	–	Show or hide the status bar.
	Refresh (R)	–	Refresh the current data.
	Data Tree (D)	–	Show or hide the data tree window
	Output (O)	–	Show or hide output window.
Search (S)			
	Find... (F)	Ctrl + F	Find the specified text.
	Replace (P)	Ctrl + H	Replace the specific text with different text.
Window (W)			
	Close (C)	Ctrl + F4	Close the window.
	Cascade (D)	–	Arrange windows so they overlap.
	Tile Horizontally (H)	–	Arrange windows as non-overlapping tiles
Help (H)			
	Version Information	–	Display program information; version number and copyright.



## Revision History

The revision dates and numbers of the revised manuals are given on the bottom of the back cover.

MANUAL NO. SIEZ-C887-13.2

© Printed in Japan November 2002 01-12 ◊  
 └─ Date of printing      └─ Date of original publication      └─ Revision number

Date of Printing	Rev. No.	Section	Revised Content
December 2001	—	—	First edition
November 2002	◊	Back cover	Revision: Address
May 2003	◊	Back cover	Revision: Address
April 2005	◊	Preface	Revision: CP717 to MPE720 Windows95 to Windows95/98/2000/NT
		Back cover	Revision: Address
August 2005	◊	Back cover	Revision: Address

# Machine Controller MP900/MP2000 Series New Ladder Editor USER'S MANUAL

---

**IRUMA BUSINESS CENTER (SOLUTION CENTER)**

480, Kamifujisawa, Iruma, Saitama 358-8555, Japan  
Phone 81-4-2962-5696 Fax 81-4-2962-6138

**YASKAWA ELECTRIC AMERICA, INC.**

2121 Norman Drive South, Waukegan, IL 60085, U.S.A.  
Phone 1-847-887-7000 Fax 1-847-887-7370

**YASKAWA ELÉTRICO DO BRASIL COMÉRCIO LTD.A.**

Avenida Fagundes Filho, 620 Bairro Saude-Sao Paulo-SP, Brazil CEP: 04304-000  
Phone 55-11-5071-2552 Fax 55-11-5581-8795

**YASKAWA ELECTRIC EUROPE GmbH**

Am Kronberger Hang 2, 65824 Schwalbach, Germany  
Phone 49-6196-569-300 Fax 49-6196-569-312

**YASKAWA ELECTRIC UK LTD.**

1 Hunt Hill Orchardton Woods Cumbernauld, G68 9LF, United Kingdom  
Phone 44-1236-735000 Fax 44-1236-458182

**YASKAWA ELECTRIC KOREA CORPORATION**

7F, Doore Bldg. 24, Yeoido-dong, Youngdungpo-Ku, Seoul 150-877, Korea  
Phone 82-2-784-7844 Fax 82-2-784-8495

**YASKAWA ELECTRIC (SINGAPORE) PTE. LTD.**

151 Lorong Chuan, #04-01, New Tech Park 556741, Singapore  
Phone 65-6282-3003 Fax 65-6289-3003

**YASKAWA ELECTRIC (SHANGHAI) CO., LTD.**

No.18 Xizang Zhong Road, Room 1702-1707, Harbour Ring Plaza Shanghai 200001, China  
Phone 86-21-5385-2200 Fax 86-21-5385-3299

**YASKAWA ELECTRIC (SHANGHAI) CO., LTD. BEIJING OFFICE**

Room 1011A, Tower W3 Oriental Plaza, No.1 East Chang An Ave.,  
Dong Cheng District, Beijing 100738, China  
Phone 86-10-8518-4086 Fax 86-10-8518-4082

**YASKAWA ELECTRIC TAIWAN CORPORATION**

9F, 16, Nanking E. Rd., Sec. 3, Taipei, Taiwan  
Phone 886-2-2502-5003 Fax 886-2-2505-1280



YASKAWA ELECTRIC CORPORATION

YASKAWA

In the event that the end user of this product is to be the military and said product is to be employed in any weapons systems or the manufacture thereof, the export will fall under the relevant regulations as stipulated in the Foreign Exchange and Foreign Trade Regulations. Therefore, be sure to follow all procedures and submit all relevant documentation according to any and all rules, regulations and laws that may apply.

Specifications are subject to change without notice for ongoing product modifications and improvements.

© 2001-2005 YASKAWA ELECTRIC CORPORATION. All rights reserved.

MANUAL NO. SIEZ-C887-13.2B

Printed in Japan August 2005 01-12 ④-0  
05-7⑦